



# Implementation of three-phase DSTATCOM using frequency domain-based voltage reference configuration (VRC) control algorithm for power quality improvement

Nur Fatini Ahmad Sobri<sup>a</sup>, Nor Hanisah Baharudin<sup>a,\*</sup>, Tunku Muhammad Nizar Tunku Mansur<sup>a</sup>, Rosnazri Ali<sup>a</sup>

<sup>a</sup>Faculty of Electrical Engineering Technology, University Malaysia Perlis, Arau, Perlis, Malaysia

(Communicated by Madjid Eshaghi Gordji)

---

## Abstract

Power quality problems in the distribution system have tremendously escalated due to numerous consumptions of various types of loads especially nonlinear loads. These problems have affected the utility grid and the consumers in the distribution system resulting in equipment breakdown, overheating in utility system equipment, and other problems related to electronics devices that are being used by the utility system and the consumers. The electronics devices are quite sensitive and can be malfunctioned even with small disruptions that occurred in the supply power system. The power quality problem involved with nonlinear loads can be mitigated by using Distribution Static Synchronous Compensator (DSTATCOM). This paper proposed a method for power quality improvement by using a Frequency Domain-based Voltage Reference Configuration (VRC) control algorithm for the Distribution Static Synchronous Compensator (DSTATCOM) in a three-phase distribution system. The performance of the proposed control algorithm is simulated in the MATLAB environment using Simulink. It is verified that the proposed control algorithm can reduce the THD of the distorted grid current at the Point of Common Coupling (PCC) below 5% according to the IEEE Standard 519:2014 under nonlinear loads and unbalanced loads conditions.

*Keywords:* Distribution Static Synchronous Compensator (DSTATCOM), Three-phase three-wire

---

\*Corresponding author

*Email addresses:* [nurfatiniahmad7@gmail.com](mailto:nurfatiniahmad7@gmail.com) (Nur Fatini Ahmad Sobri), [norhanisah@unimap.edu.my](mailto:norhanisah@unimap.edu.my) (Nor Hanisah Baharudin), [tunkunizar@unimap.edu.my](mailto:tunkunizar@unimap.edu.my) (Tunku Muhammad Nizar Tunku Mansur), [rosnazri@unimap.edu.my](mailto:rosnazri@unimap.edu.my) (Rosnazri Ali)

*Received:* August 2021    *Accepted:* September 2021

---

*2010 MSC:* Please write mathematics subject classification of your paper here.

---

## 1. Introduction

The power quality is a major concern for the power engineer due to the rises of nonlinear loads consumption in the industrial, commercial, and domestic loads for a three-phase three-wire (3P3W) distribution system which induces harmonics in power source components [1]. Harmonics is an integer multiply of the frequency in sinusoidal voltage and current based on the Fourier series and repeated every cycle and also refers to a periodic quantity component with an order larger than one of the Fourier series, such as the harmonic order 3rd (sometimes known as the "third harmonic"), which is 150 Hz in a 50 Hz system [20]. Voltage harmonics are more problematic than current harmonics because voltage harmonics only appear when a current harmonic is present, and current harmonics are the result of nonlinear load and have an impact on the supply system [27, 26]. Usually, an odd integer multiple of power frequency appears in the distribution power system and affects the amplitude of the signal as well as the crest factor which is generally caused by the 3rd harmonic component. The consequence of the harmonic current injection from customers loads into the utility supply system caused harmonic distortion in the utility system and affected the utility system equipment as well as other customers equipment which lead to power quality problems at the point of common coupling (PCC) [13]. A thorough review of works literature on the method for mitigating the power quality problem especially harmonic distortion has been done, the research studies introduced the mitigating device known as a custom power device (CPD) at the power common coupling (PCC) to mitigate power quality problem and supply good quality of power supply to the customers in the distribution system [7]. There is numerous study on CPD integrating with renewable energy showed the improvement in power quality device technology as showed in [19, 2, 21].

This study focuses on the current harmonic distortion caused by the dynamic nonlinear load that gives an atrocious impact on the power quality in the power system. The shunt type of CPDs, DSTATCOM is being implemented to mitigate the power quality problem related to the current disturbance such as nonlinear loads, unbalanced load, and harmonic distortion [18]. The attribution of DSTATCOM is capable to mitigate the issues caused by deficient load power factor and voltage regulation, harmonic from the nonlinear load, the effect of unbalanced load and can achieve load-leveling when the absence of supply happen if incorporate with the energy storage system. A thorough literature review on 'control technique for DSTATCOM' introduced several novel methods of fundamental component extraction, harmonic compensation technique, and synchronization supply for seamless operation of grid system when an encounter with the nonlinear load takes place [4, 22].

The performance of DSTATCOM relies upon its reference signal generation techniques. The control algorithms that are described in the literature for the control of DSTATCOM may be divided into two categories: time-domain and frequency-domain [22]. The domination of time-domain control in most of DSTATCOM control technique literature has been found and is preferred because of their faster and ease of implementation compared to the frequency-domain method. However, the frequency-domain control algorithm presents better detection performance compared to the time domain. Furthermore, the frequency-domain method is suitable for single-phase and three-phase systems while time-domain is mostly implemented for three-phase systems [11]. However, most previous works implemented frequency domain control algorithms for a single-phase VSI system [10]. The previous work of frequency-domain control algorithm including Fast Fourier Transform (FFT) [12], discrete Fourier Transform (DFT), and Kalman filter [16] being implemented into active power conditioner device.

Based on this work, the proposed control algorithm is verified on the variety of load conditions which

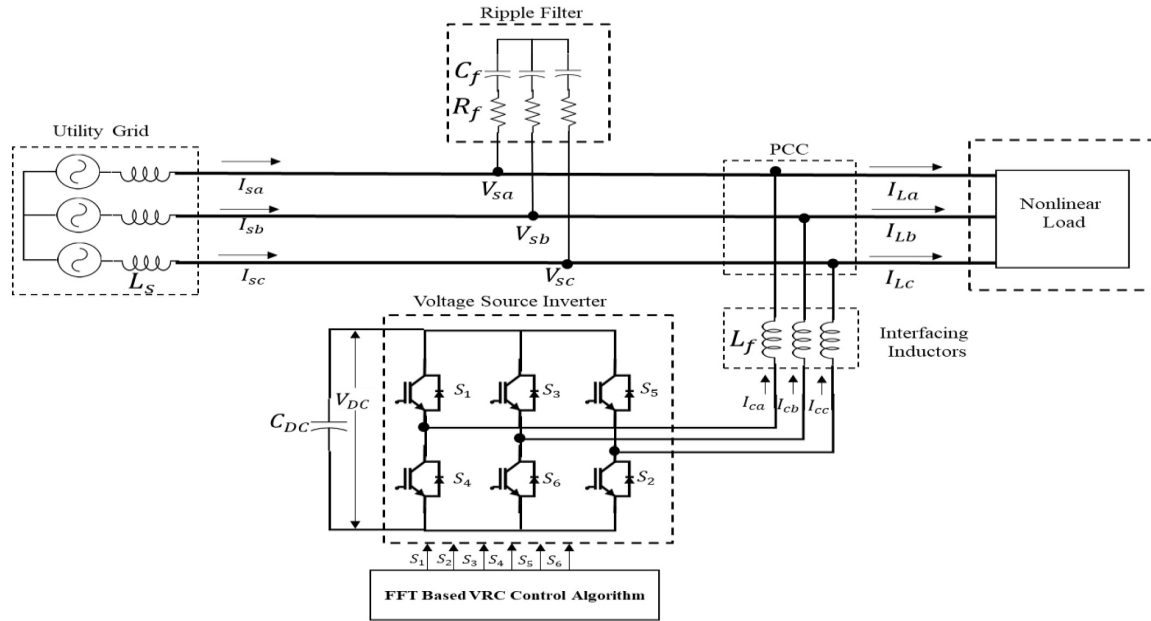

Figure 1: Basic circuit diagram of a DSTATCOM system with Frequency Domain-based VRC control algorithm for 3P3W distribution system

are unbalanced load for linear and nonlinear loads with the obtained results that have satisfied the objectives of improving power quality at PCC and followed the IEEE-519 standard. This paper is organized in the following manner: Introduction and objectives of the research work are described in Section 1 while the methods involved are explained in Section 2. Section 3 presented the results and discussion. Lastly, Section 4 summarized the conclusion

## 2. Literature Review

The frequency-domain methods are mostly identified with Fourier analysis, which is reorganized in such a way that the result is provided as quickly as possible with a lessening number of computations, allowing for real-time implementation in digital signal processors (DSP). Figure 1 illustrated the method of the frequency domain that is present by past literature reviews such as Fourier series theory, Discrete Fourier transform theory (DFT), Fast Fourier transform theory(FFT), Recursive Discrete Fourier transform theory (RDFT), Kalman filter-based control algorithm, Wavelet transformation theory, Stockwell transformation (S-transform) theory, Empirical decomposition (EMD) transformation theory, and Hilbert–Huang transformation theory [22, 6].

## 3. System Configuration

Figure 1 shows a three-phase three-wire DSTATCOM circuit diagram connected with an uncontrolled rectifier and resistive–inductive (R–L) load to simulate the nonlinear loads. Besides, a circuit breaker is used to disconnect a phase load to realize the unbalanced load. The DSTATCOM system is a three-phase voltage source inverter (VSI) comprised of six insulated-gate bipolar transistors (IGBTs) with antiparallel diodes. In order to remove high-frequency components of the generated compensating current, the interfacing inductors are connected at the ac side of the VSI. Then, the ripple filters are placed at PCC to remove the switching ripples produced by the VSI.

Table 1: The literature work for the application of the Frequency Domain algorithm

Frequency Domain Control Algorithm	Device	Description
FFT	Shunt Active Filter	In order to obtain sinusoidal and balanced waveforms of the compensated current, the shunt compensation compensates the current losses of the active power filter with respect to the fundamental positive sequence of the load current [8].
Kalman filter-based control algorithm	Unified Power Quality Conditioner	The state components of uncompensated load current and voltage supply have been extracted by using a Kalman filter which is used as a state observer [16].
FFT	Inverter	Fast Fourier Transform (FFT) has been utilized as its major processing technique to take advantage of the speed of computation [23].
RDFT	Shunt Active Power Filter	For the production of reference compensating current, a frequency domain method known as Adaptive Recursive DFT is used. This approach is stable even when the system frequency varies, and it solves the disadvantages of the traditional Fourier transform technique [24].
FFT	Grid Tie Inverter	By using the FFT algorithm to extract reference current to compensate the harmonic in a photovoltaic system (PV) inverter [5]
Wavelet transformation theory	Unified Power Quality Conditioner	This control approach is used to estimate the phase angle of voltages in a novel control strategy that is intended to reduce harmonics as well as unsymmetrical components.[9]
Hartley S-transform	PV-DSTATCOM	The suggested control algorithm is a novel control method for calculating the fundamental load component and analyzing the time-frequency signal. The S-transform may be thought of as a development and enhancement of the Short-Time Fourier Transform (STFT) and Wavelet Transformation (WT)[17].
Dual tree-complex wavelet	DSTATCOM	The proposed controller can identify the fundamental component of the distorted load current from the decomposed level for harmonic elimination and load balancing [15].

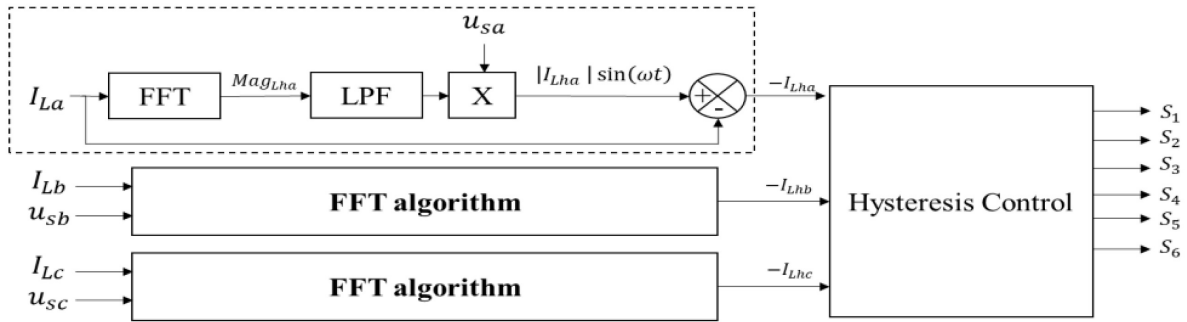

Figure 2: Frequency Domain-based VRC Control Algorithm

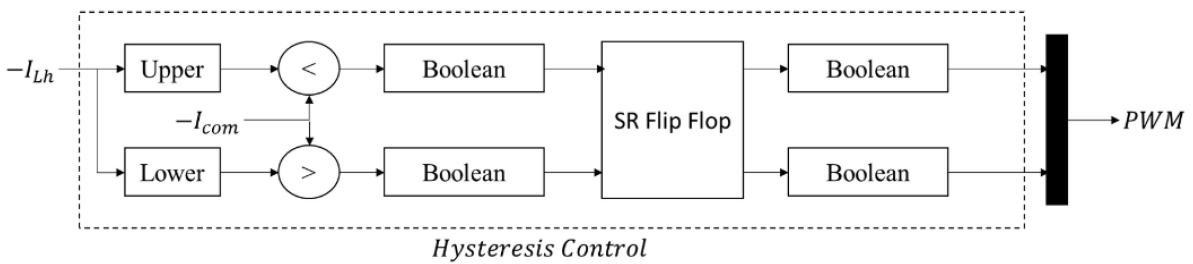

Figure 3: Hysteresis Current Control

#### 4. Control Technique

As shown in Figure 2, the Frequency Domain-based VRC control method is utilized to extract the fundamental reference current and the hysteresis current control (HCC) as described in [25] is liable to produce a voltage Source inverter (VSI) gate pulse (see Figure 3). For harmonic component extraction from load currents, the Frequency Domain-based VRC control algorithm is used [3]. the technique is utilized to trigger IGBTs of VSI, which has decreased parameter requirements, to eliminate harmonic distortion. The detailed control structure consists of three sections: (a) calculation of unit templates, (b) evaluation of load harmonic components and estimation of reference currents, and (c) switching of VSI, which are described as follows.

##### 4.1. Frequency Domain-based VRC Control Algorithm

###### A. Estimation of Unit-Templates

The line voltage ( $V_{sa}, V_{sb}, V_{sc}$ ) is sensed at PCC. The in-phase component of the line voltage (4.1) is calculated by multiply the with the constant value  $c$  (4.2) to produce a unity sinusoidal wave (4.3).

$$V_{sa} = \sqrt{2} \times 240 \sin(\omega t) \quad (4.1)$$

$$c = \frac{1}{\sqrt{2} \times 240} \quad (4.2)$$

$$f_a = \frac{1}{\sqrt{2} \times 240} x \sqrt{2} \times 240 \sin(\omega t) \quad (4.3)$$

Same goes to  $V_{sb}$  and  $V_{sc}$  (4.4).

$$\begin{aligned}fb &= V_{sb} \times c \\fc &= V_{sc} \times c\end{aligned}\tag{4.4}$$

*B. Extraction of load harmonic component and reference signal current.*

For estimated fundamental components of harmonics in load, the Frequency Domain-based VRC algorithm is used. The load current is assumed to be symmetrical, resulting from the equation for the harmonic component of load current based on the FFT rule as shown in equation (4.5) for  $I_{La}$ . The load current consists of the 5th and 7th harmonic and the FFT block eliminated the odd harmonics and produces the even harmonics.

$$I_{Lha}(t) = \sum_{n=1}^{\infty} \frac{2I_A}{n\pi} \sin\left(\frac{n\pi}{2}\right) \cos(2\pi ft)\tag{4.5}$$

Then, the magnitude of the harmonic component is filtered by using a low pass Butterworth filter for better starting response and multiply with the in-phase component of line voltage as given in (4.6).

$$I_{Lharef}(t) = I_{Lha}(t) \times f_a\tag{4.6}$$

The same goes to  $I_{Lb}$  and  $I_{Lc}$ .

$$\begin{aligned}I_{Lhb}(t) &= \sum_{n=1}^{\infty} \frac{2I_B}{n\pi} \sin\left(\frac{n\pi}{2}\right) \cos(2\pi ft) \\I_{Lhc}(t) &= \sum_{n=1}^{\infty} \frac{2I_C}{n\pi} \sin\left(\frac{n\pi}{2}\right) \cos(2\pi ft)\end{aligned}\tag{4.7}$$

$$\begin{aligned}I_{Lhbref}(t) &= I_{Lhb}(t) \times f_b \\I_{Lhcref}(t) &= I_{Lhc}(t) \times f_c\end{aligned}\tag{4.8}$$

*C. Generation of fundamental reference current and switching of VSI*

Because of load current contains a 5th and 7th harmonic, the negative harmonic is given as (4.9) to make sure grid current is sinusoidal by inserting harmonic compensation current component through PCC into the nonlinear load ??.

$$\begin{aligned}-I_{Lha}(t) &= I_{Lharef}(t) - I_{La} \\-I_{Lhb}(t) &= -I_{Lhbref}(t) - I_{Lb} \\-I_{Lhc}(t) &= -I_{Lhcref}(t) - I_{Lc}\end{aligned}\tag{4.9}$$

The generation of the reference signal is estimated by the hysteresis gap as shown in Figure 3 to generate an error signal to produce the switching pulse for the VSI. The hysteresis control uses to measure the upper and lower limit of reference signal based on compensation current and given as (4.10).

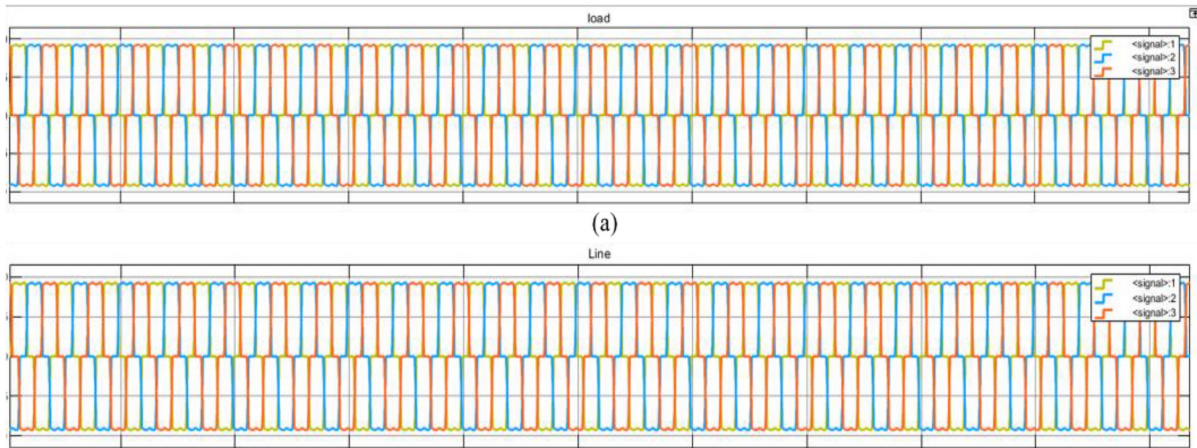

Figure 4: Simulation results for the three-phase distribution system under steady-state nonlinear load condition without DSTATCOM compensation (a) load current (b) grid current.

$$-I_L = |I_{Lh}| \sin(\omega t) - I_L \quad (4.10)$$

By comparing the reference signal with the compensator current from the VSI output, the signal can be sent to produce a switching pulse for the VSI to achieve the objective of the system. The hysteresis current control consists of a comparator, and flip-flop and the PWM signal is generated from flip-flop output [14].

## 5. Result and Discussion

### 5.1. DSTATCOM Performance under Nonlinear Load Condition

#### A. Steady-State Condition.

Performance of the steady-state response for the load and grid current in the three-phase distribution system under nonlinear load without DSTATCOM compensation is shown in Figure 4. The three-phase nonlinear load waveforms consist of the harmonic contents distorted the waveforms of the grid current. This is due to the injection of the harmonic components from the nonlinear load into the grid current and effected the ideal sinusoidal waveform of the grid currents into distorted waveforms in the three-phase distribution system. The THD value for grid current,  $I_S$  is 25.32% which is the same as the nonlinear load current,  $I_L$  as shown in Figure 5 is a proof that the nonlinear load effected the utility system due to the harmonic injection into the distribution system. The obtained THD value of the grid current at PCC is beyond the permissible limit of the IEEE 519-2014 standard which stated that THD value of the grid current at PCC must be less than 5%.

The performance of the three-phase distribution system with DSTATCOM compensation under steady-state nonlinear load condition can be seen in Figure 6. The waveforms of the grid current as shown in Figure 6(a) have been improved at PCC and become in-phase as well as sinusoidal despite of having the distorted waveforms of the load currents in Figure 6(b) due to the nonlinear load connection. The DSTATCOM compensation currents are illustrated in Figure 6(c) have been injected at the PCC to improve the power quality issue due to nonlinear load connection. Figure 7(a) shows the THD value of the grid current after DSTATCOM compensation at PCC is improved to 1.89% and comply with the permissible limit of 5% corresponding to the IEEE-519:2014 standard as compared to the THD value of the load current of 19.69% which is presented in Figure 7(b). The odd harmonic contents of the grid current are also eliminated. Thus, the VSI based DSTATCOM

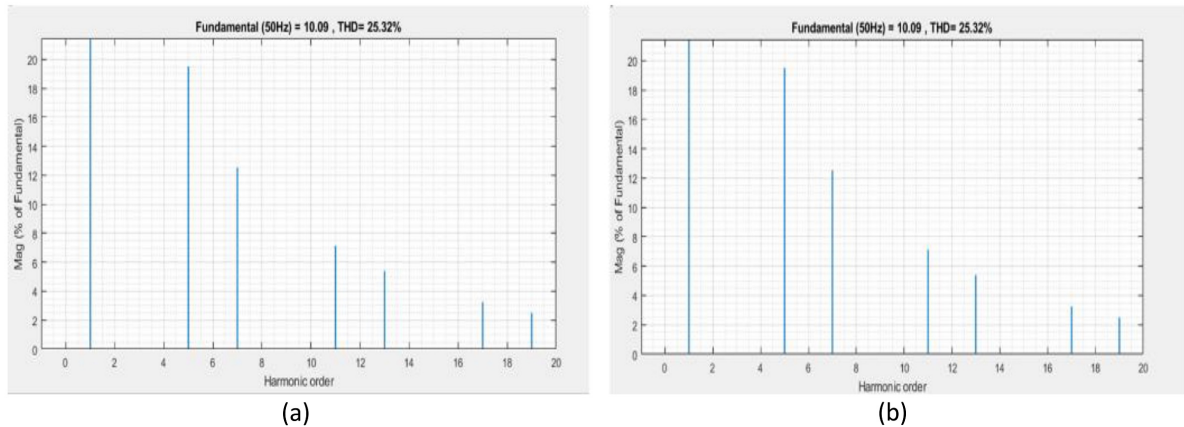

Figure 5: Harmonic spectrum for the nonlinear load condition without DSTATCOM compensation (a) grid current (b) load current.

with the proposed frequency domain based VRC control algorithm has successfully compensated the harmonic contents of the grid current at the PCC under steady-state nonlinear load condition. Furthermore, the dc bus voltage of the VSI based DSTATCOM is also regulated at the constant reference value of 700 V by using the proposed control algorithm.

### B. Dynamic Condition.

The performance of the three-phase distribution system with DSTATCOM compensation under dynamic condition has been simulated and illustrated in Figure 8. Figure 8(b) shows that the phase 'a' load is removed from 1 sec to 1.05 sec to assess the dynamic impact of the unbalanced load in the three-phase distribution system with DSTATCOM compensation. It is shown that after removing a load of phase 'a', the load current becomes zero and affects the load current of phase 'b' and phase 'c'. However, due to precise control of the proposed control algorithm, the grid current in Figure 8(a) is balanced and becomes sinusoidal waveform at PCC eventhough in the presence of the unbalanced load current. The VSI based DSTATCOM is capable to inject the compensation current at PCC in Figure 8(c) to overcome the sudden change of unbalanced nonlinear load condition and maintain its dc bus voltage at the reference value of 700V in Figure 8(d). The THD value of load current after removal of the phase 'a' load is 44.87%, yet the grid current stays within the permitted limit of 5% based on the IEEE-519:2014 standard which is 3.58% as shown in Figure 9. Thus, the control algorithm is successful for balancing the unbalanced nonlinear load condition and the grid current waveforms remain balanced and sinusoidal.

Figure 10 shows the performance of the three-phase distribution system under sudden removal of three-phase nonlinear load. The three-phase load currents are temporarily disconnected at 8s to 8.05s in Figure 10(b) and tested for the simulation. After the sudden disconnection of the load, the performance on the three-phase grid current waveforms are illustrated in Figure 10(a). Due to the proper control of the proposed control algorithm, the grid currents are balanced and remained sinusoidal even during the sudden disconnection of the three-phase nonlinear load. The VSI-based DSTATCOM is capable to inject the compensation current to improve the grid current waveforms at the PCC as presented in Figure 10(c) and regulate its dc bus voltage at the new reference value in Figure 10(d). The THD value of load current after removal of the three-phase nonlinear load is 45.22% as can be seen in Figure 11(b). However, the THD value of the grid current is reduced to 4.43% and remained within the permissible limit of 5% according to the IEEE-519:2014 standard as shown in Figure 11(a). In a conclusion, the control algorithm is successful in solving the temporary



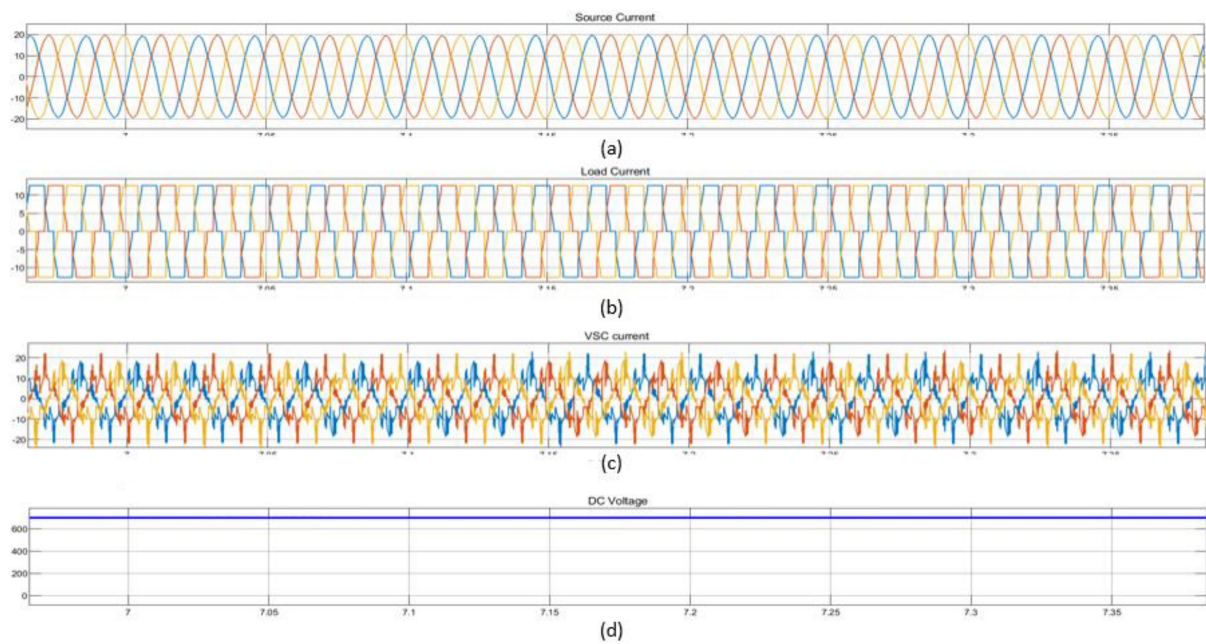

Figure 6: Simulation results for the three-phase distribution system under steady-state nonlinear load condition with DSTATCOM compensation (a) load current and (b) grid current (c) VSI base DSTATCOM compensation current and (d) DC bus voltage.

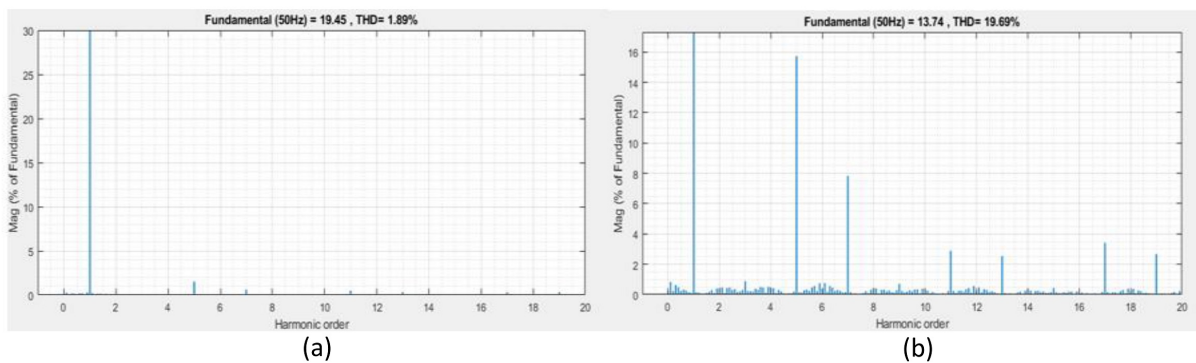

Figure 7: Harmonic spectrum for the three-phase distribution system under steady-state nonlinear load condition with DSTATCOM compensation (a) grid current (b) load current.

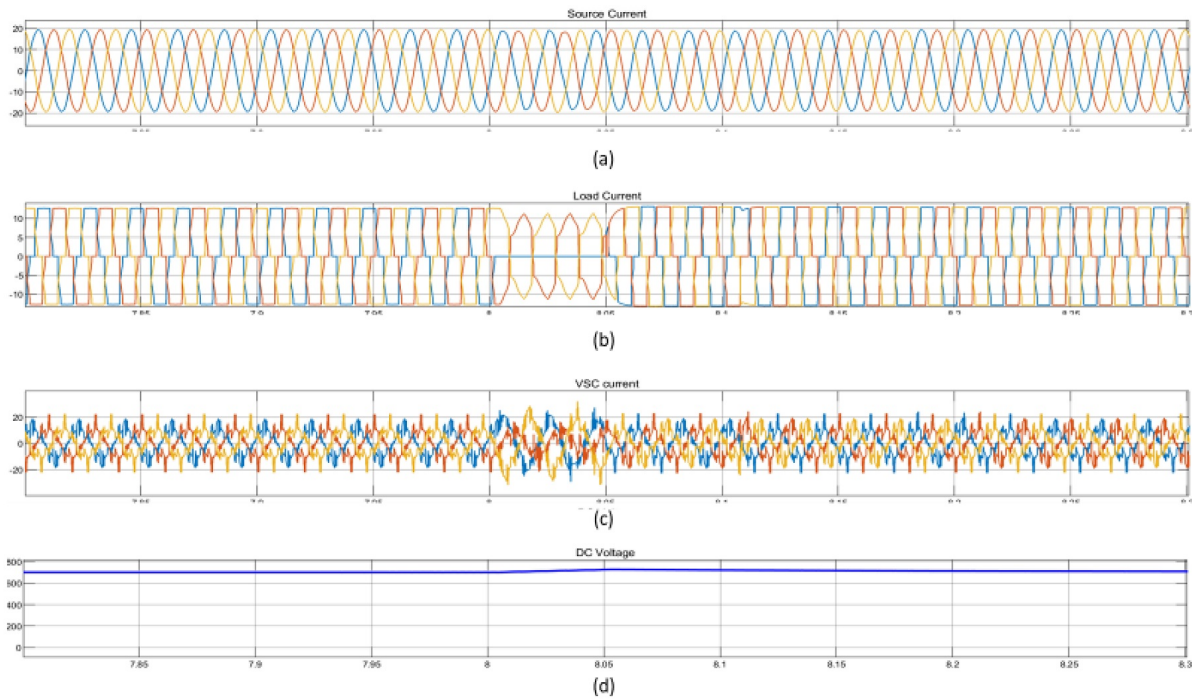

Figure 8: Simulation result for the unbalanced nonlinear load with DSTATCOM compensation (a) grid current (b) load current (c) VSI base DSTATCOM compensation current and (d) DC bus voltage

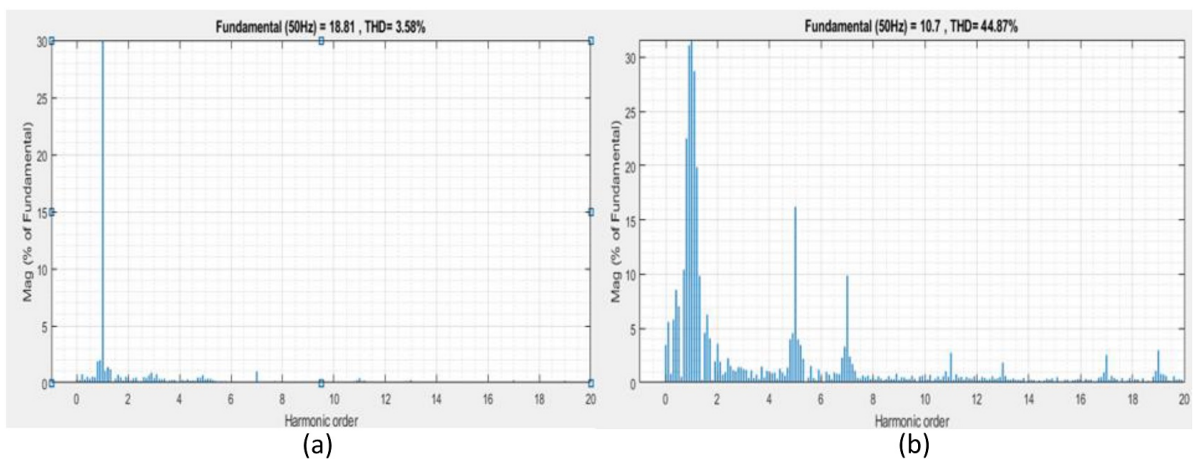

Figure 9: Harmonic spectrum for the unbalanced nonlinear load with DSTATCOM compensation (a) grid current (b) load current.

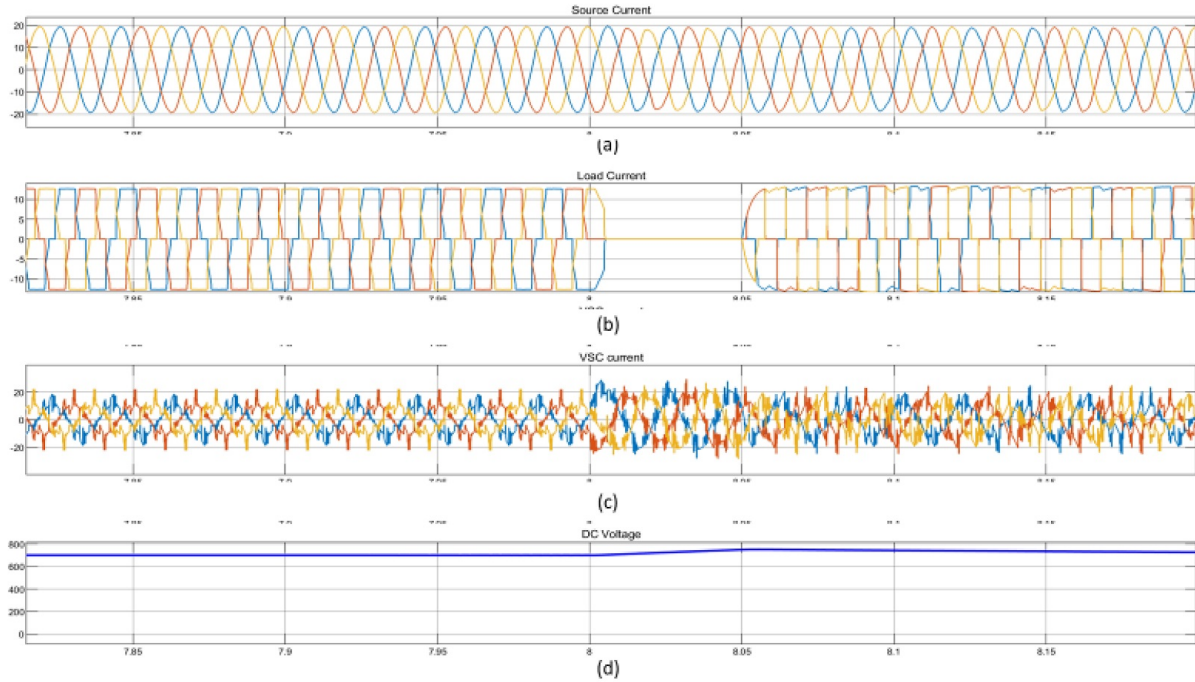

Figure 10: Performance of the three-phase distribution system under sudden removal of nonlinear load with DSTATCOM compensation (a) grid current (b) load current (c) VSI base DSTATCOM compensation current and (d) DC bus voltage

Table 2: Summary of the THD value results %

Load Case Study	Grid Current (%)	Load Current (%)
Steady-State without DSTATCOM compensation	25.32	25.32
Steady-State with DSTATCOM compensation	1.89	19.69
Dynamic unbalanced non-linear load condition with DSTATCOM compensation	3.58	44.87
Dynamic disconnection of non-linear load condition with DSTATCOM compensation	4.43	45.22

disconnection of the three-phase nonlinear load condition and the grid current waveform remains balanced and sinusoidal.

### 5.2. Summary of the Results

Table 2 shows the summary of the results for the overall performance of DSTATCOM in the three-phase distribution system under nonlinear load condition with Frequency Domain-based VRC control algorithm in different conditions of load case study. The value of dc bus voltage is remained constant at 700V in each condition of the load case study. Before the DSTATCOM compensation for the three-phase distribution system, the THD value of the grid current is the same as the THD value of the load current because of the existence of harmonic contents in the nonlinear load which have distorted the grid current. The DSTATCOM is capable to compensate the harmonics in the load currents and resulting in the grid currents remain sinusoidal and not affected by the condition of the load. Thus, the THD value of the grid currents are maintained within the specified limit of 5% following the IEEE-519:2014 standard after DSTATCOM compensation under nonlinear load condition for steady-state and dynamic load case study.

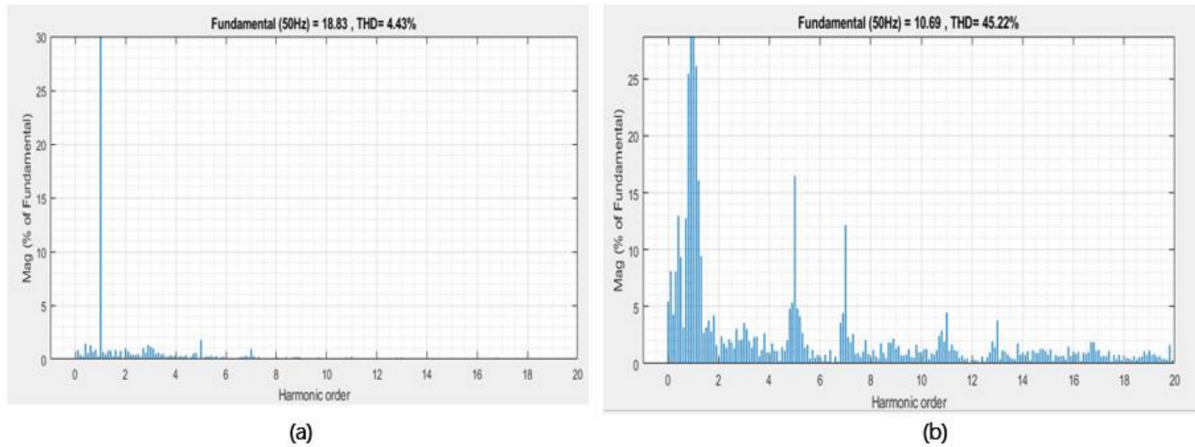

Figure 11: Harmonic spectrum for the three-phase distribution system under sudden removal of nonlinear load with DSTATCOM compensation (a) grid current (b) load current

## 6. Conclusion

Frequency domain-based VRC control algorithm for the three-phase distribution system under nonlinear load for dynamic and steady-state conditions are implemented in this paper. The proposed control algorithm has successfully achieved the standard of IEEE-519 by eliminating the current harmonics and maintain the THD value at PCC below 5%. The advantages of the Frequency Domain-based VRC control algorithm are an easy and simple implementation for power quality improvement in terms of harmonic compensation as well as load balancing in the three-phase distribution system. The control approach works well under the steady-state and dynamic conditions which are verified via MATLAB simulation.

## Acknowledgment

This work was supported by the Fundamental Research Grant Scheme (FRGS) under a grant number of *FRGS/1/2020/TK0/UNIMAP/02/113* from the Ministry of Higher Education Malaysia.

## References

- [1] A.M.M. Alzubaidi and P.V. Ramana Rao, *Harmonic compensation and distributed generation integration in BLDC drive system with multi functional DSTATCOM*, J. Crit. Rev. 7(7) (2020) 11–16.
- [2] K. Ananda-Rao, R. Ali, S. Taniselass and N.H. Baharudin, *Microcontroller based battery controller for peak shaving integrated with solar photovoltaic*, 4th IET Clean Energy Tech.Conf. (CEAT 2016) (2016) 1–6.
- [3] N.H. Baharudin, T.M.N.T. Mansur, S.I.S. Hassan, P. Saad, R. Ali and M.Y. Lada, *A comparison of distribution static synchronous compensator (dstatcom) control algorithms for harmonic elimination*, ARPN J. Eng. Appl. Sci. 10(22) (2015) 10740–10744.
- [4] A. Banerji, S.K. Biswas and B. Singh, *DSTATCOM control algorithms: A review*, Int. J. Power Electron. Drive Syst. 2(3) (2012) 285–296.
- [5] H. Bin, Q. Hua and H. Cui, *A technique for FFT harmonics compensation and leakage current suppression in 10kW PV inverter*, in Proceedings of The 7th International Power Electronics and Motion Control Conf. 2 (2012) 836–840.
- [6] P.T. Cheng, S. Bhattacharya and D. Divan, *Experimental verification of dominant harmonic active filter for high-power applications*, IEEE Trans. Ind. Appl. 36(2) (2000) 567–577.
- [7] T. Devaraju, *Role of custom power devices in power quality enhancement: A review*, Int. J. Eng. Sci. Technol., 2(8) (2010) 3628–3634.

- [8] P. Dhanamjaya, *Improvement of power quality using FFT for shunt active filters*, Int. J. Curr. Res. Sci. Eng. Technol. 1(1) (2016) 1–5.
- [9] M. Forghani and S. Afsharnia, *Wavelet based control strategy for UPQC control system used for mitigating voltage sag*, IECON 2006 - 32nd Annual Conference on IEEE Industrial Electronics, (2006) 2003–2008.
- [10] B. Han, *Single-phase active power filter using FFT with harmonic phase-delay compensation*, 2009 IEEE Power Energy Soc. General Meet. (2009) 1–6.
- [11] P. Hurkadli and D.B. Kulkarni, *Comprehensive review of DSTATCOM for power quality improvement*, Int. J. Eng. Technol. Sci. Res. 4(5) (2017) 2394–3386.
- [12] M. Inci, M. Buyuk and M. Tumay, *FFT based reference signal generation to compensate simultaneous voltage sag/swell and voltage harmonics*, 2016 IEEE 16th Int. Conf. Envir. Elect. Engin. (EEEIC) (2016) 1–5.
- [13] R. Ingale, *Harmonic analysis using FFT and STFT*, Int. J. Signal Process. Image Process. Pattern Recognit. 7(4) (2014) 345–362.
- [14] A.N. Jog and N.G. Apte, *An adaptive hysteresis band current controlled shunt active power filter*, 5th Int. Conf. Compat. Power Electron. CPE 2007, (2007) 8031–8040.
- [15] R. Kumar, B. Singh, D.T. Shahani and C. Jain, *Dual-tree complex wavelet transform-based control algorithm for power quality improvement in a distribution system*, IEEE Trans. Ind. Electron., 64(1) (2017) 764–772.
- [16] K.H. Kwan, P.L. So and Y.C. Chu, *An output regulation-based unified power quality conditioner with Kalman filters*, IEEE Trans. Ind. Electron. 59(11) (2012) 4248–4262.
- [17] K. Mathuria, I. Hussain and B. Singh, *Power improvement using hartley S-transform for solar energy conversion system*, 2017 4th IEEE Uttar Pradesh Sect. Int. Conf. Electr. Comput. Electron. UPCON 2017, 2018 (2017) 427–433.
- [18] Y. Naderi, S.H. Hosseini, S. Ghassem Zadeh, B. Mohammadi-Ivatloo, J.C. Vasquez and J.M. Guerrero, *An overview of power quality enhancement techniques applied to distributed generation in electrical distribution networks*, Renew. Sustain. Energy Rev. 93(March) (2018) 201–214.
- [19] S.K. Pandey, S. Kumar and B. Singh, *Robust frequency cascaded sdaptive complex filter control for grid interactive PV system*, IEEE Trans. Ind. Appl., 57(1) (2021) 130–138.
- [20] D.M.F.G. Roger, *IEEE recommended practice and requirements for harmonic control in electric power systems*, IEEE Std. 519-2014, 2014 (2014).
- [21] S.K. Sahoo, S. Kumar and B. Singh, *VSSMLMS-based control of multifunctional PV-DSTATCOM system in the distribution network*, IET Gener. Transm. Distrib. 14(11) (2020) 2100–2110.
- [22] B. Singh, A. Chandra and K. Al-Haddad, *Power Quality: Problems and Mitigation Techniques*, John Wiley & Sons, 9(2) 2015.
- [23] S.S. Sinha, J. Shah and H. Nerkar, *Harmonics measurement using FFT algorithm in digital signal controller for smart micro-grid system*, in 2016 IEEE Region 10 Humanitarian Technology Conference (R10-HTC) (2016) 1–5.
- [24] B. Urmila, D. Gupta and S.K. Chauhan, *Investigations on mitigation of harmonics by fast fourier transform controlled shunt active power filter*, Int. J. Electron. Eng. Res. 9(6) (2017) 831–844.
- [25] H. Vahedi, E. Pashajavid and K. Al-Haddad, *Fixed-band fixed-frequency hysteresis current control used in APFs*, IECON Proceedings (Industrial Electronics Conference) (2012) 5944–5948.
- [26] A. Yuvaraj, *Elimination of harmonics in power system using FFT analysis*, Int. J. Adv. Res. Comput. Commun. Eng. 3297(11) (2007) 468–470.
- [27] M.A.A.M. Zainuri, M.A.M. Radzi, A.C. Soh, N. Mariun, N.A. Rahim and S. Hajighorbani, *Fundamental active current adaptive linear neural networks for photovoltaic shunt active power filters*, Energies 9(6) (2016) 1–20.