



Study and implementation sinusoidal PWM inverter fed 3-phase induction motor

Ola Hussein Abd Ali Alzuabidi^a

^a*Dijlah University College, Computer Engineering Techniques, Iraq*

(Communicated by Madjid Eshaghi Gordji)

Abstract

This paper presents a simulation, implementation and simplified implementation of the study and development of an induction motor equipped with a built-in sine pulse width SPWM inverter. PSIM software is used to simulate PWM switching strategies as well as basic problems that are less than THD, efficient use of DC bus, etc. Simulation is also concerned with minor problems like EMI reduction, switching loss, and fine harmonics distribution with optimum battery. The results used experimentally and in implementation proved the superior performance and effectiveness of the filter in reducing and obviously unwanted distortions.

Keywords: SPWM, SVPWM, Harmonics Analysis, Induction Motor, THD.

1. Introduction

DC motors are less common than AC motors, therefore, it is necessary to have a variable source of high-power variable-voltage when using AC motors [1, 2, 3, 4, 5, 6, 7, 8, 9, 10]. The research has been extensively used in studying PW modulation schemes in the past two decades [11]. The PWM systems were implemented and simulated for realizing adaptable voltage and variable frequency in AC transformers as in [12, 13, 14, 15, 16, 17, 18, 19]. Variable speed drives (VSDs) and fixed frequency shifters (SFCs) as well as uninterruptible power supplies (UPS) all use PWM technology over a large range [20, 21, 22]. Power electronics design engineers face fundamental problems in reducing the harmonics present in inverter circuits [23, 24, 25, 26, 27]. For small or moderate power appliances, a classic square wave inverter is used which undergoes a critical defect like low order harmonics in an external wave [28, 29, 30]. To get rid of these shortcomings and to improve the environment free of harmful harmonics in huge power transformers is the use of control systems in a sine wave width modulator. The goal of using PWM methods is to implement and manufacture a sinusoidal AC output from which its value and frequency can be reduced.

Email address: ola.hussien@duc.edu.iq (Ola Hussein Abd Ali Alzuabidi)

2. Literature review

The electrical switch is controlled by a device called an inverter, where electrical sources are converted from one state to another, such as DC-AC or AC-DC. In small network systems, an effective three-legged IGBT inverter is designed by simulating MATLAB2014a/Simulink. The inverter switches are controlled by a pulse controller which mainly generates the gate switching pulse. The switching pulse control module includes two levels inline pulse width, phase lock loop (PLL), constant voltage, current regulator and uref generator. [27, 29].

Most industries today operate mostly on induction motors that rely on a three-phase AC voltage source.

AC supply is not available in three phases all the time, especially in rural areas. For this reason, a new design of a single-phase to three-phase inverter has been proposed using the MOSFET. To obtain variable frequency AC for induction motors, PWM technology is used because it provides variable speed control which in turn deals with wide energy savings and reduces electricity cost [20, 23].

Simulation results are compared with the scale of the location that was carried out from the power plant.

Pulse with modulation (PWM) was used as the switching technique in this design. Despite the benefits of a pulse width modulator in providing ease of frequency filter (LC) implementation and low total distortion (THD), the voltage amplitude of the inductive output wave is lower. To solve this problem, a three-phase transformer is incorporated into the design to obtain the desired results. The results proved that the target AC parameters for all phases were achieved after comparing them with the site measurement [22].

In this paper, an improved full-bridge transformer was built and designed by adding two separate capacitors, transformers and an improved rectifier stage. The designed and proposed transformer is controlled by the asymmetrical pulse width modulator. This transformer provides reduced current ripple of an external filter inductor so this model is designed with a power of 1 kW [15].

Because of the radial electromagnetic vibration of a permanent magnet motor (pmsm), it is difficult to reduce noise not only at high frequencies but also at low frequencies. So, the most appropriate way to solve this problem is to propose a method for modulating the pulse width of the stochastic non-equilibrated carrier wave, which enables the reduction of the vibration in the entire frequency range. Instead of the traditional symmetric tripod PWM, the low phase and low vibration harmonics are reduced through the use of an asymmetric carrier (ACpwm) and this carrier provides through wide sawtooth carrier randomization to reduce the current harmonics for high-frequency phase [17].

Predictive controls are widely applied to electric motors because they provide a fast dynamic response to multivariate control and non-linear systems. The control of AC electric motors uses online prediction and optimization processes, but this requires a high computational ability for fast dynamics, and this is a complex process in terms of including constraints in the design of the control unit. Therefore, a non-linear and multivariable predictive control unit for an induction motor is proposed in this paper [28].

In this paper, the phase voltage wave control scheme (pvoc) is used by the power factor control element of the permanent magnet synchronous wind generator (PMSG). Depending on the design of the control unit (PI). The results show the simulated control in (PSIM) system performance that is carried out by checking using the TITMS320F28335 digital chip [30].

3. Materials and Methods

Three-phase reference modulation signals are compared in the sine wave with a typical three-carrier for generating the three-phase PWM signals. PSIM software technology was used to simulate the system used in this study and implementation. The powerful and efficient power electronics environment is provided by PSIM software as well as graphical user interface drivers. Using the waveform display program's post-processing functions, this program is easy to use, implement, and simulate by preparing the circuit and editing its results clearly and accurately. The features of PSIM include:

1. It's easy to use.
2. Simulator that is quick.
3. Displaying controls in a flexible way
4. Modules built-in.
5. Modules that can be added.
6. Sweep of the parameters
7. Waveform display in real time.

PSIM's simulator setting is highly interactive, allowing operators to interact with the simulation. In the middle of a simulation run, users can make changes to parameters and monitor simulation waveforms. System model blocks and their parameters are listed as follows:

1. Voltage source inverter motor drive system.
2. Ac output motor.
3. Fundamental frequency 50Hz.
4. Switching frequency 20kHz.
5. Dc voltage 380Volt.

4. Trial and Error method using PSIM program

To obtain simulation and implementation results and the possibility to change each parameter in the subsequent 5 parts in an inverter drive system, using PSIM program in an easy and flexible way.

1. 3-phase MOSFET bridge SPWM inverters switch frequencies.
2. Modulations indexing and V/f ratios.
3. 3-phase inductions motors.

The motor specifications : 3-phase 380 line volt I.M, 2pole, 50Hz,1100watt 2800rpm. $R_s = 6\Omega$, $X_s = 25.13\Omega$, $R_r = 15\Omega$, $X_r = 12.5\Omega$ and $X_m = 300$.

5. Results and discussion of SPWM.

The foremost purpose for any technology used is for obtaining adaptable outputs with basic and necessary components with minimum harmonics. The purpose or intent of using PWM systems is for indicating the basic external voltage and reduce the total harmonic content of three-phase voltage source transformers. Diverse PWM systems have been compared in this paper based on THD. This is done by developing simulation models of the inline sine pulse width. THD is a high value so the results are executed when there is no loading process. In this paper, three magnitudes for the modulation index (90% and 50% of the magnitude) have been considered for providing all the different ranges of THD change.

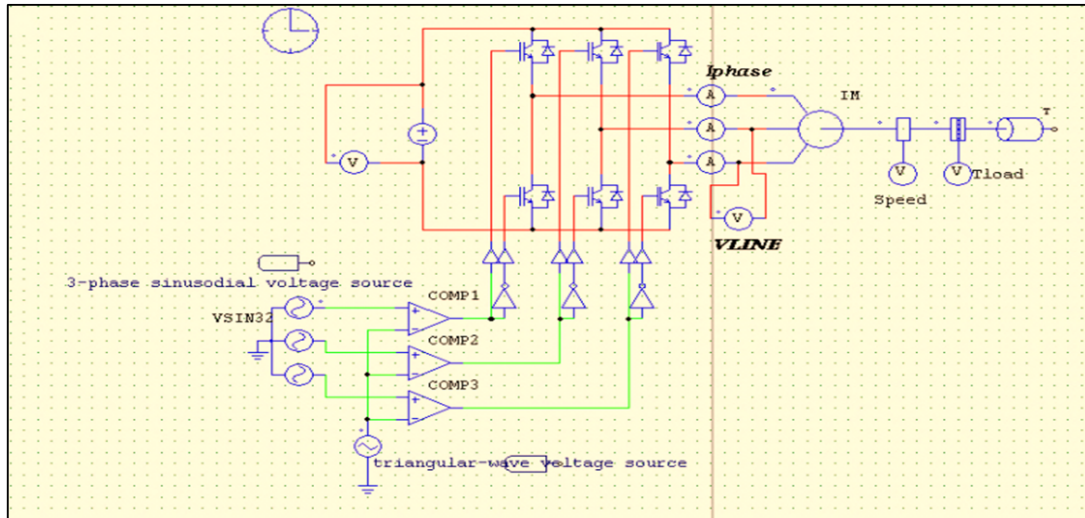

Figure 1: illustration for SPWM Inverter fed induction motor

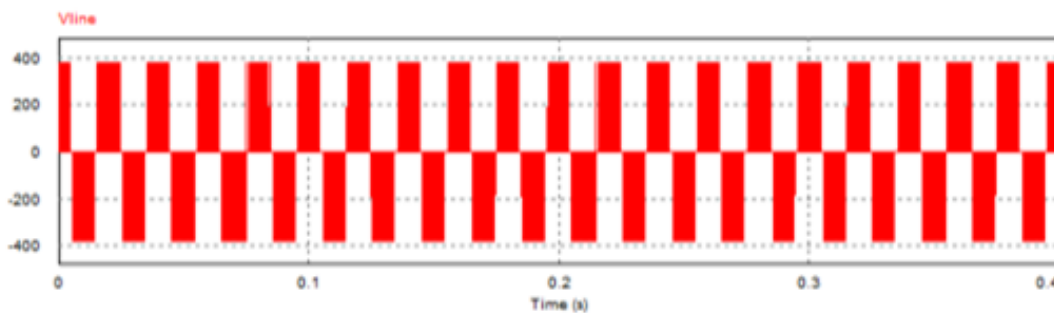

Figure 2: SPWM lin voltages .

5.1. Simulation of SPWM

A typical triangular carrier has been used to compare 3 phase reference modulating signals and generate PWM signals for the 3 phases. As a result, the voltage utilization has been poor amid 0 percent and 78.5 percent of six-step voltage magnitudes. Because of their fixed switching frequencies, conventional SPWM output waves have a fixed frequency. A modulation index has adjusted varied from 0 to 1. Lastly, a behavior for chaos-based SPWM has been evaluated with SPWM. Figure-1 shows an illustration of a Sinusoidal pulses width modulating inverters fed induction motors. Accordingly, Figures 2 and 3 depict the line voltage and current responses.

5.2. SPWM vs. SVPWM control for three phase inverters: comparison

As part of variable speed applications, voltage source inverters are generally employed for supplying a 3-phases induction motor with variant frequencies and voltages. Headed for obtaining the necessary output voltage on the inverter line side, an appropriate pulse width modulation (PWM) can be utilized. It is possible to divide the different methods of PWM generation into two broad categories: Triangles comparisons PWM and Spaces Vectors PWM (SVPWM). The 3 phase references modulated signal have evaluated and a typically triangular carrier in TCPWM approaches like sine-triangle PWM for generating the PWM signals for the 3 phases. The revolving reference voltage vector was employed in place of 3-phase modulating waves in SVPWM methods. It stands for frequency for reference vector that regulates the value and frequency for a fundamental constituent

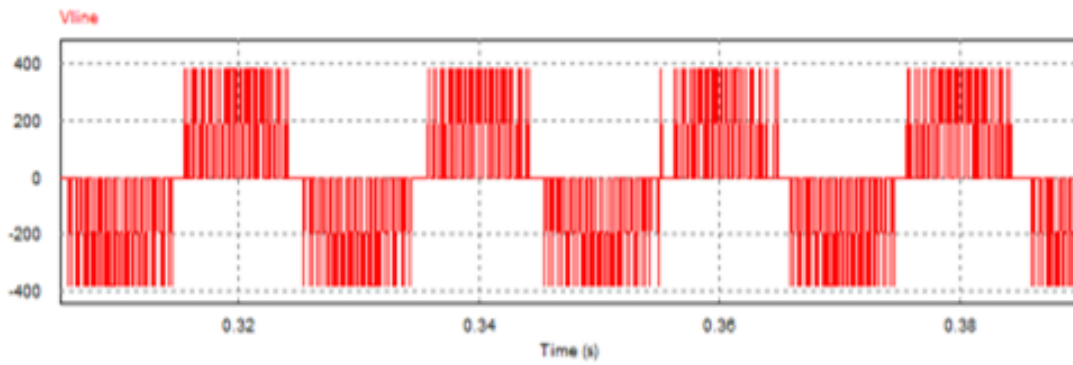

Figure 3: SPWM line voltage wavefoems .

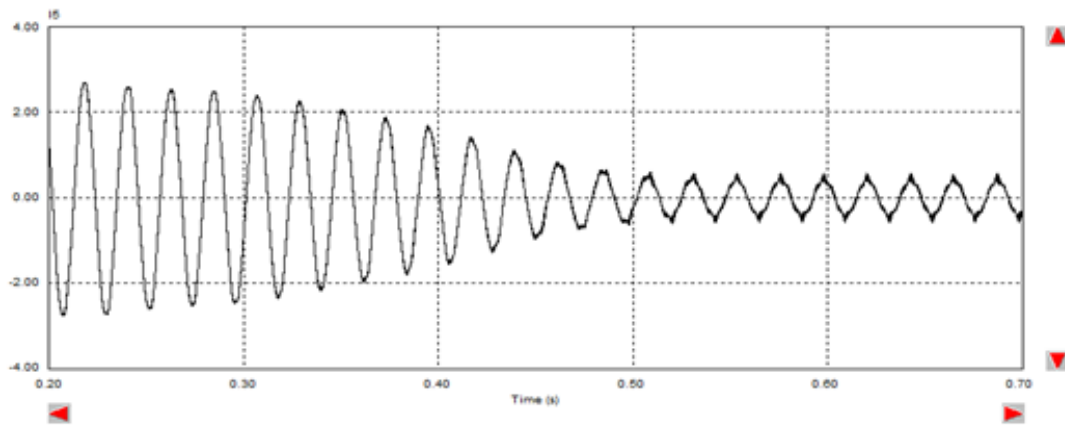

Figure 4: line current in SPWM lines currents waveforms .

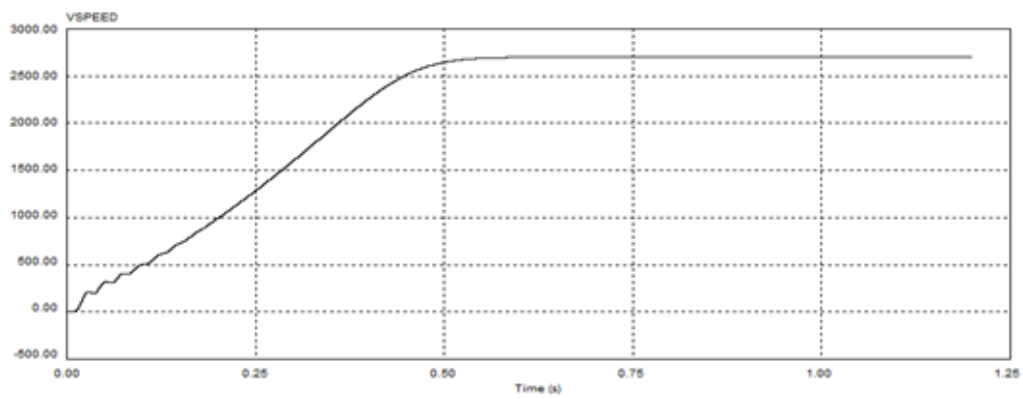

Figure 5: SPWM speed of rotors.

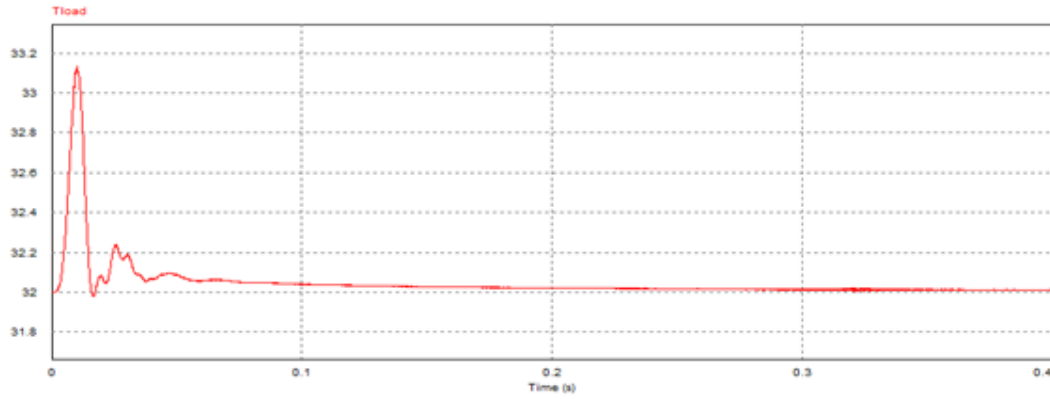

Figure 6: SPWM torques.

on the equation line side, correspondingly. PWM using a sine triangle has a lower peak phase fundamental than PWM using a space vector, which has a much higher peak phase fundamental. Inverters with three-phase voltage sources control AC induction, switched reluctance, permanent magnets synchronous and brushless DC motor based on the Space Vector Modulations (SVM) method. Space vector modulation is more efficient at using DC buses voltages and produces low harmonics distortions than Sinusoidal PWM (SPWM), according to a new study by researchers. With the help of the PSIM SIMULATION software, a model of Space vector PWM is created and its performance has compared with Sinusoidal PWM. Instead of using a dc bus voltage, space vector PWM makes better use of it and produces less THD.

5.3. Simulated consequences for SPWM and SVPWM

Table 1:

Modulation Index %	SPWM INVERTER		SVPWM INVERTER	
	Fundamental <i>mArms</i>	THD %	Fundamental <i>mArms</i>	THD %
90	383.2	2.7	438	6.3
70	255	2.4	233	4.7
50	234	2	214	2.3

Table 2:

Modulation Index %	SPWM INVERTER		SVPWM INVERTER	
	Fundamental Vrms	THD %	Fundamental Vrms	THD %
90	136.2	4.4	196.2	4.2
70	126.6	5.6	146.2	7.6
50	160.5	5.3	155.2	5

6. Conclusion

Drives that use AC power are more common than drives that use DC power. Variable voltage and frequency power supplies are required for ac drives. In the last two decades, a lot of work has been done on pulse width modulation schemes. Variable voltage and variable frequency are achieved using PWM techniques in both AC-DC in addition to DC-AC converters. It is the primary goal for any modulation technique for producing an adjustable output with an optimum fundamental component and a minimum harmonic component. PWM systems are used in Three-Phase Voltage Source Inverters to improve central output voltage and reduce harmonics. On the basis of Total Harmonic Distortion, PWM techniques are compared in this study (THD).

In conclusion, the following points have been made:

1. Using PSIM's flexibility for output filter design, the trial-and-error method is simple and accurate.
2. It is employed for any modulation method, resultant in diverse harmonic spectrums of the inverter's output.
3. With the intention of achieving a worthy compromise and optimizing the complete drive system, diverse switching frequencies can be achieved

In industrial applications, any drive system with a similar power rating can be designed using the same design methodology.

References

- [1] X. Huang, D. Chang, C. Ling and T.Q. Zheng, *Research on single-phase PWM converter with reverse conducting IGBT based on loss threshold desaturation control*, Energies 10(11) (2017) 1845.
- [2] Z. Yu, A. Mohammed and I. Panahi, *A review of three PWM techniques*, Proc. Am. Control Conf. Albuquerque, New Mexico, 1997, pp. 257–261.
- [3] D.G. Holmes and T.A. Lipo, *Pulse width modulation for power converters: Principles and practice*, Ed. M.E. El-Hawary, New Jersey: IEEE Press, Wiley- Interscience, 2003, pp. 215–313.
- [4] T. Erfidan, S. Urugun, Y. Karabag and B. Cakir, *New software implementation of the space vector modulation*, Proc. IEEE Conf. 2004, pp. 1113–1115.
- [5] D. Rathnakumar, J.L. Perumal and T. Srinivasan, *A New software implementation of spwm inverter*, Proc. IEEE SoutheastCon. 2005, pp. 131–136.
- [6] B. Hariram and N.S. Marimuthu, *Space vector switching patterns for different applications- A comparative analysis*, Proc. IEEE Conf. 2005, pp. 1444–1449.
- [7] R.H. Ahmad, G.G. Karady, T.D. Blake and P. Pinewski, *Comparison of Space Vector Modulation Techniques based on performance Indexes and Hardware Implementation*, Proc. IECON'97 23rd Int. Conf. Ind. Electron. Control Instrum. (Cat. No.97CH36066), 1997, pp. 682–687.
- [8] W. Shireen, S. Vanapalli and H. Nene, *A DSP based SVPWM control for utility interactive inverters used in alternate energy systems*, IEEE Trans. Ind. Electron., 2006.
- [9] B.K. Bose, *Power Electronics and Ac Drives*, Prentice Hall Inc., Englewood Cliffs, New Jersey, 1986.

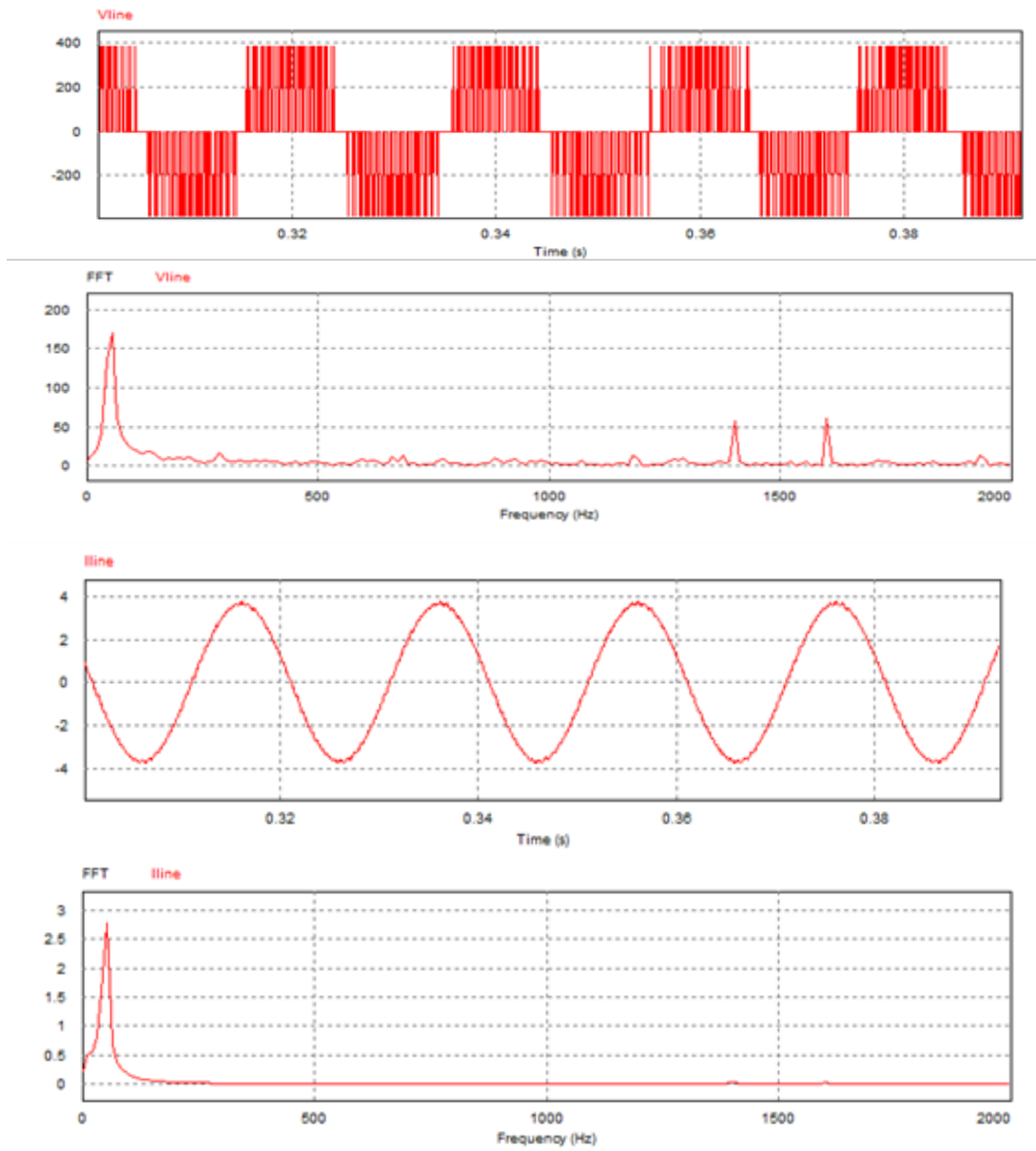

Figure 7: voltages (v) besides currents (I) and harmonic for 90% rating

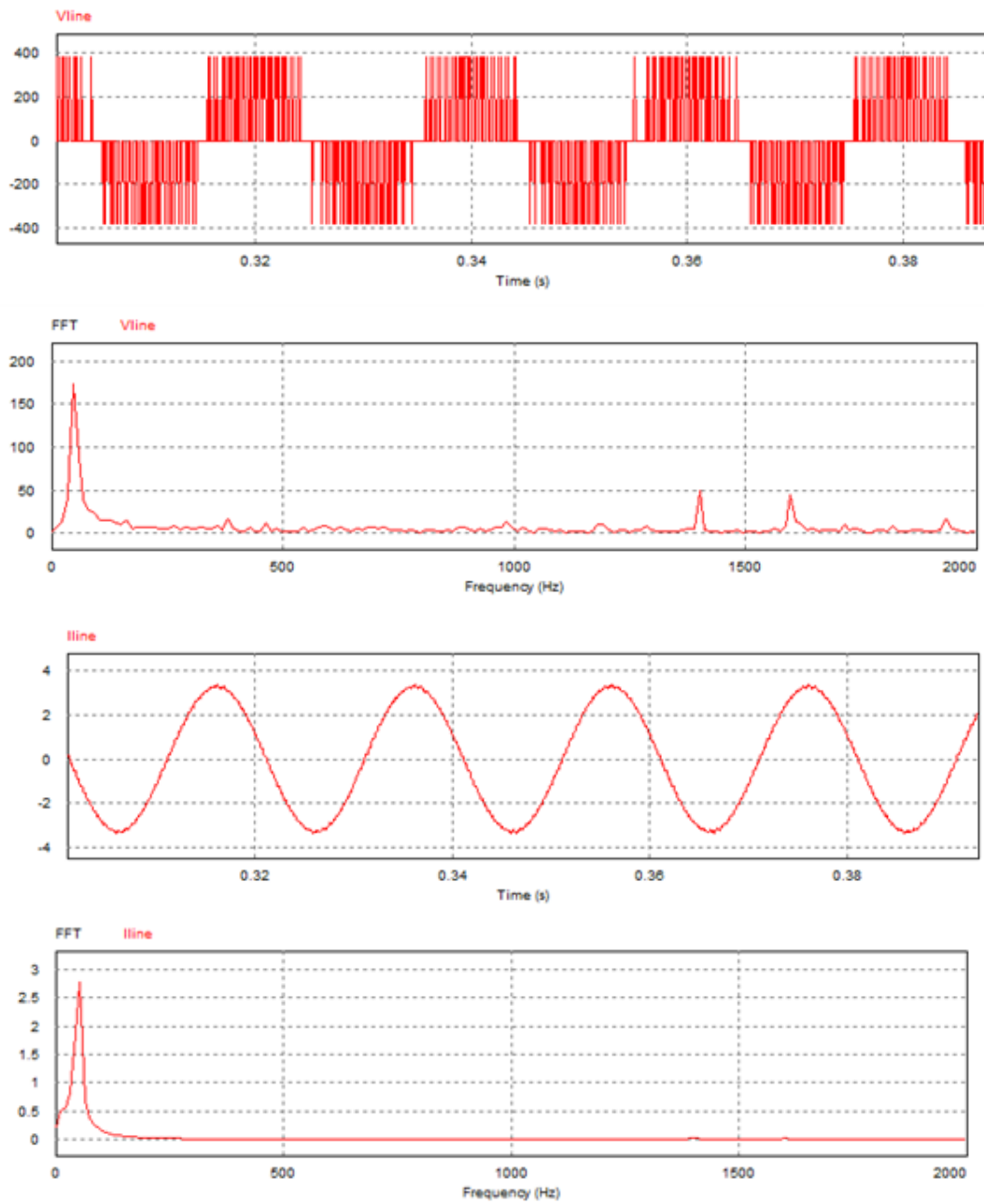

Figure 8: voltages (v) and currents (I) and harmonic for 70% rating

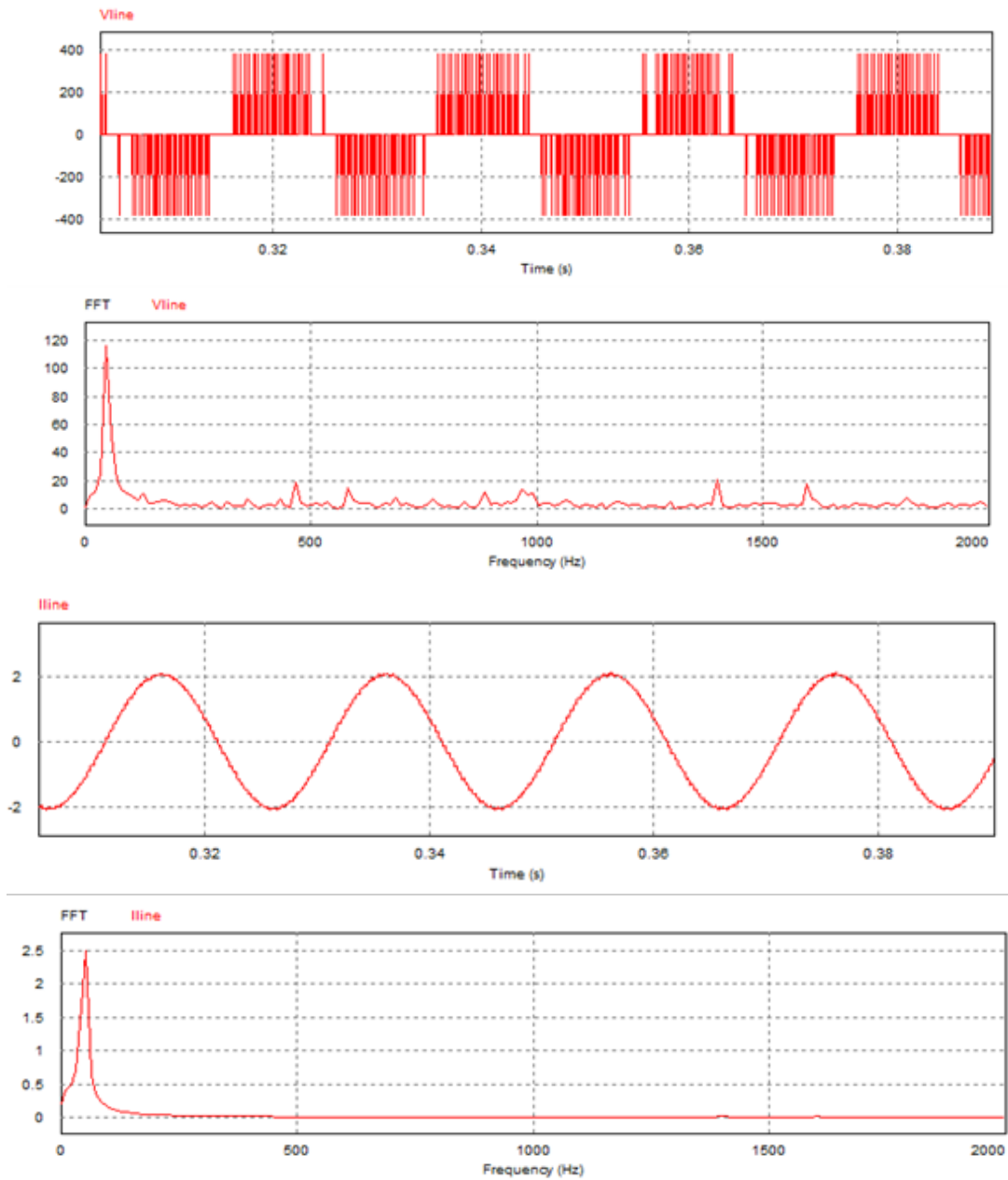

Figure 9: voltages (v) and currents (I) and harmonic for 50% rating

- [10] C. Bharatiraja, S. Jeevananthan, R. Latha and V. Mohan, *Vector selection approach-based hexagonal hysteresis space vector current controller for a three phase diode clamped MLI with capacitor voltage balancing*, IET Power Electron. 9 (2016) 1350–1361.
- [11] G. Li, C. Liu, Z. Fu and Y. Wang, *A novel RPWN selective harmonic Elimination method for single-phase inverter*, Electron. 9 (2020) 489.
- [12] D. Jiang and F. Wang, *Variable switching frequency PWM for three-phase converters based on current ripple prediction*, IEEE Trans. Power Electron. 28 (2013) 4951–4961.
- [13] Y.S. Lai, Y.T. Chang and B.Y. Chen, *Novel random-switching PWM technique with constant sampling frequency and constant inductor average current for digitally controlled converter*, IEEE Trans. Ind. Electron. 60 (2012) 3126–3135.
- [14] J. Zheng, M. Lyu, S. Li, Q. Luo and K. Huang, *Common-mode reduction SVPWM for three-phase motor fed by two-level voltage source inverter*, Energies 13 (2020) 3884.
- [15] Y. Zhu, Z. Guo and B. Han, *An Improved Full Bridge Asymmetrical PWM Controlled DC-DC Converter for Circulating Current Reduction*, In: IEEE 9th Int. Power Electron. Motion Control Conf. (IPEMC2020-ECCE Asia), 2020, pp. 1324–1331.
- [16] R. Selvaraj, K. T. Desingu, R. Chelliah, D. Khare and C. Bharatiraja, *Fault tolerant operation of parallel-connected 3L-neutral-point clamped back-to-back converters serving to large hydro-generating units*, IEEE Trans. Ind. Appl. 54 (2018) 5429–5443.
- [17] J. Xu and H. Zhang, *Random asymmetric carrier PWM method for PMSM vibration reduction*, IEEE Access 8 (2020) 109411–109420.
- [18] T. Pu, F. Bu, W. Huang and L. Zhu, *Implementation of random SVPWM strategy for three-phase voltage source inverter based on FPGA*, Proc. 20th Int. Conf. Electr. Mach. Syst. (ICEMS), Sydney, Australia, 11–14 August 2017, pp. 1–4.
- [19] Y. Huang, Y. Xu, W. Zhang and J. Zou, *Hybrid RPWM technique based on modified SVPWM to reduce the PWM acoustic noise*, IEEE Trans. Power Electron. 34 (2019) 5667–5674.
- [20] C. Bharatiraja, R. Selvaraj, T.R. Chelliah, J.L. Munda, M. Tariq and A.I. Maswood, *Design and implementation of the fourth arm for elimination of bearing current in NPC-MLI-Fed induction motor drive*, IEEE Trans. Ind. Appl. 54 (2018) 745–754.
- [21] Y. Huang, Y. Xu, W. Zhang and J. Zou, *Hybrid periodic carrier frequency modulation technique based on modified SVPWM to reduce the PWM noise*, IET Power Electron. 12 (2019) 515–520.
- [22] Y. Huang, Y. Xu, W. Zhang and J. Zou, *PWM frequency voltage noise cancellation in three-phase VSI using the novel SVPWM strategy*, IEEE Trans. Power Electron. 33 (2018) 8596–8606.
- [23] A.F. Abouzeid, J.M. Guerrero, A. Endemaño, I. Muniategui, D. Ortega, I. Larrazabal and F. Briz, *Control strategies for induction motors in railway traction applications*, Energies, 13 (2020) 700.
- [24] G. Sieklucki, *An Investigation into the Induction Motor of Tesla Model S Vehicle*, In: Proc. IEEE 2018 Int. Symp. Electr. Mach. (SME 2018), Miyazaki, Japan, 10–13 June 2018.
- [25] T.H. Liu, S. Ahmad, M.S. Mubarak and J.Y. Chen, *Simulation and implementation of predictive speed controller and position observer for sensorless synchronous reluctance motors*, Energies 13 (2020) 2712.
- [26] C.H. Lin, *Permanent-magnet synchronous motor drive system using backstepping control with three adaptive rules and revised recurring sieved pollaczek polynomials neural network with reformed grey wolf optimization and recouped controller*, Energies 13 (2020) 5870.
- [27] I. Ferdiansyah, M.R. Rusli, B. Praharsena, H. Toar, Ridwan and E. Purwanto, *Speed Control of Three Phase Induction Motor Using Indirect Field Oriented Control Based on Real-Time Control System*, Proc. IEEE 2018 10th Int. Conf. Inf. Technol. Electr. Eng. (ICITEE 2018), Bali, Indonesia, 24–26 July 2018.
- [28] F. C. Rosa and E. Bim, *A constrained non-linear model predictive controller for the rotor flux-oriented control of an induction motor drive*, Energies 13 (2020) 3899.
- [29] F. Alonge, M. Cirrincione, F. D’Ippolito, M. Pucci and A. Sferlazza, *Robust active disturbance rejection control of induction motor systems based on additional sliding mode component*, IEEE Trans. Ind. Electron. 64 (2017) 5608–5621.
- [30] M.F. Tsai, C.S. Tseng and B.Y. Lin, *Phase voltage-oriented control of a PMSG wind generator for unity power factor correction*, Energies 13 (2020) 5693.