

# Nonlinear dynamic analysis and the impact of viscous damper on implemented vibration control applied to seismic vibrations

Mohammad Reza Arefi

*Department of Civil Engineering, Technical and Vocational University (TVU), Tehran, Iran*

*(Communicated by Zakieh Avazzadeh)*

---

## Abstract

In the present paper, the impacts of viscous dampers on controlling the vibrations imposed on seismic vibrations are evaluated using descriptive methods. To this end, the library method and other research related to viscous dampers and their impacts on controlling external excitation such as earthquakes have been used. ETABS software was used for modelling the structures. Also, nonlinear dynamic analysis was used for seismic analysis of the structures. Based on the findings, using viscous dampers are effective to improve seismic parameters of structure and to decrease displacement, speed, base shear, and velocity. On the other hand, viscous fluid dampers can strengthen the structure and its performance during severe earthquakes and can be applied in newly constructed structures. The impact of a passive viscous damper on reducing the seismic response of the structures is found significant at the confidence level of 90%. Reduction of energy of structure hysteresis because of the nonlinear behaviour of members using dampers is proved to be significant at the confidence level of 80%. The results reveal that the lateral resistance of an EBF with a short joint can be 4/5 to 9 times more than the lateral resistance of an MRF, that the behaviour coefficient of fifteen-story EBF considered 6/5-7/75, concluded that the length of the bray does not have an impact on the behaviour coefficient of these frames.

Keywords: Damper, Viscous damper, Seismic vibrations, Vibrations, Nonlinear dynamic analysis  
2020 MSC: 70Kxx

---

## 1 Introduction

Among natural disasters, earthquake has been discussed more because of its unpredictable nature and how it damages human-made structures. It seems that the method that should be used in order to confront earthquake, is not predicting but retrofitting. The new perspective discussed in recent decades is to find a way to reduce, control or omit the energy imposed to the structure by the earthquake. Omitting the energy imposed to the structure, we can hinder damages to the main members of the structure. Among them, fluid viscous damper is one of the most practical tools used for controlling the structure responses [6].

The main task of a structure is to endure the effective loads imposed on it and to transfer them to the foundation. The lateral forces imposed to the structure have a dynamic nature causing vibration in the structure. During the last 50 years, earthquakes have been divided into near-field and far-field classes based on the distance of their recorded place from the fault. However, this definition was later modified, and other factors besides distance were also regarded in this classification. Considering the destructive effects of some recent earthquakes such as Northridge (1994), Kobe

---

*Email address:* [arefi.mr@gmail.com](mailto:arefi.mr@gmail.com) (Mohammad Reza Arefi)

(1995) and Taiwan (1999), the constructions of cities located near the active faults and investigation in this field should be regarded as important. Fluid viscous damper is the most commonly used tool for controlling structures' responses. Fluid viscous dampers with different construction technologies are applied in order to decrease the responses of structures to the seismic vibrations.

During the recent years, controlling structure has turned into a scientific technology to protect structures against wind and earthquake loads. This way of coping with the lateral loads is classified into three main classes of passive control, semi-active control and active control based on the need of input energy. Using passive control tools is highly considered due to the lack of need for input energy, easy installation, simple performance, and low cost of repair and maintenance. In this case, fluid viscous damper can be mentioned which is one of the most common tools for controlling the behavior of structures applied in passive and semi-active forms in order to decrease the response of building structures, bridges, and etc. against seismic excitations [4].

Structures go through replacement because of the forces imposed by the earthquake. The most common method for controlling the -usually lateral- replacement of the locations in steel structures is using braces. A new type of frame bridging piece that recently has been used increasingly is called eccentrically braced frames (EBF). Because of non-elastic behaviors of link beams, EBFs have more plasticity compared to convergent brace. Also, just like convergent braces, this system has a good elastic rigidity. EBF combines and uses the two features of "proper lateral rigidity" and "high energy absorbance" [4].

In this system, eccentric bracing causes the development of bending moments and shear forces at the beam area near the anchor. Therefore, the stresses of this part of the beam enter the inelastic area and cause the dissipation of the energy caused by the earthquake. This part of the beam is called joint. A joint acts like plastic-fuse and absorbs a great amount of the energy caused by the earthquake. Because of depreciation of energy, implementing fluid viscous dampers in EBFs improves the seismic behavior of EBFs that are exposed to earthquakes of the near areas. Viscous damper with damping ratio of 10 to 30 percent has a desirable impact on the seismic behavior of EBFs. EBFs have been closely studied since 1970s. Popov et al. stated that EBFs have the criteria of seismic design (stiffness and plasticity), compared to other lateral load-bearing systems like CBF or MRF. These frames show great stiffness in minor and average earthquakes, and have proper plasticity in severe earthquakes [11].

The results of the research done by Lin et al. revealed that the behavior coefficient of EBFs is highly influenced by the length of the joint. Studies on relative and total replacement of the models also revealed that the length of the beam has an impact on its value [9]. Mansoori figured out that EBF systems in steel structures have proper functioning in terms of energy absorbance and providing the proper stiffness. The function of these systems depends on the behavior of the joint. Geometric and mechanical features of the joint and its length are influential in seismic behaviors of these systems [12].

Asfar et al. studied the retrofitting of steel structures using viscous dampers, and investigated on the impacts of earthquakes happening in the near areas. They found out the structures' response is completely different in records near the fault and far from it [1]. Jiuhong et al. studied the impact of different lengths of joints on seismic performance of steel structures. Their studies revealed that the length of the joint has a great effect in the performance of the structures [7].

Xu et al. investigated the structures' behavior under the pulse-like ground motions. They displayed that adding to the pulse-like ground movement period to natural period of the structure ratio, and also adding to the ground acceleration to yield strength ratio cause increase in nonlinear response and imposed damages [16]. Lee et al. designed structures based on the popular regulations and studied their behavior at the time of earthquakes in near areas. They displayed that the requirements imposed on flexible structures with long period or isolated structures are remarkably beyond their capacity [8].

Lopez Garcia showed the frequency of big and heavy structures of nuclear power plant are between 4 to 10 Hz. Also, studying the vulnerability of implemented components in each ceiling level under the response spectrum of the acceleration of each level revealed that earthquakes with high frequency can have impacts on the safety of equipment implemented in a structure. It displayed that earthquakes near the fault do not badly damage the equipment with natural high frequency [10].

El-Borgi et al. investigated on different methods of structure modeling regarding the records for two steel buildings (9 stories and 20 stories) with moment frame near the fault and far from it. The results revealed that the model assumed with a line in the middle of the members is softer and weaker than the other models. It was suggested that for evaluating buildings with the connections, consider gravity frame in modeling before Northridge and damages structures [5]. Occhiuzzi studied the impact of earthquakes near faults on the pillars designed based on Caltrans v 1.3 regulations. In these researches, it was figured out that under the records having directivity impacts persistent

deformations remained in both pillars [13].

## 2 Performance of fluid viscous damper

Ideal output force of a viscous damper is determined using the following equation.

$$F_D = C|\dot{u}|^\alpha \text{sgn}(\dot{u}) \tag{2.1}$$

where  $F_D$  is the damping force,  $C$  is damping index,  $\dot{u}$  is the relative velocity between two ends of the damper and  $\alpha$  is a number between zero and one.  $\alpha=1$  Damper is a linear viscous damper that have a damping force in accordance with its relative velocity. Dampers with  $\alpha < 1$  are called nonlinear viscous dampers and are effective in minimizing the high velocity shocks. Figure 1 displays the force-velocity relations for three types of viscous dampers. In low velocities,  $\alpha < 1$  dampers have bigger damping forces compared to the other two types.

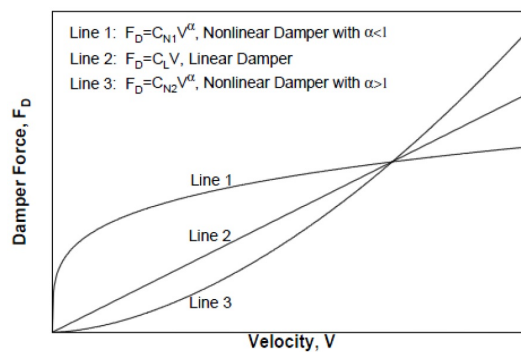

Figure 1: Force-velocity relations of viscous dampers

Figure 2 displays Hysteresis cycle of pure linear viscous behavior. In this condition, the cycle looks like a complete oval. When the frequency content of the earthquake is low, which is usually sufficient for covering seismic frequencies of first mood of structures, fluid viscous dampers do not display excessive rigidness. Therefore, the application of above-mentioned dampers in structures is in the main natural period and does not affect the shape of the structure’s mood. In other words, natural frequency of the structure and the damper are the same which simplifies the designing process advantages for structures with additional dampers. if the returning force is produced in the damper the cycle’s form changes from 2-a to 2-b. in other words, its behavior changes from viscous to viscoelastic.

While using these dampers in a structure, depreciatory viscous forces have different phase compared to other structural forces. So that when stages experience most displacements, viscous force is zero. Therefore, using viscous dampers in retrofiting buildings hinders stress damages of weak columns.

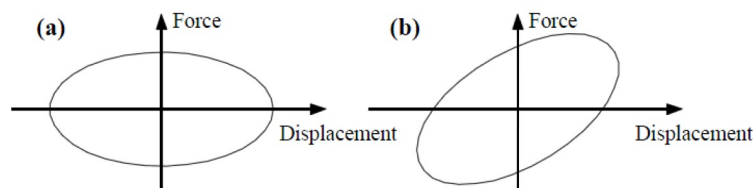

Figure 2: Hysteresis cycle of dampers with the behavior of linear and nonlinear viscous

## 3 The proportion of effective damping of structures which have linear viscous dampers

Consider a one-degree-of-freedom system equipped with a linear viscous damper that is influenced by the following sinusoidal displacement.

$$u = u_0 \sin \omega t \tag{3.1}$$

where  $u$  is the replacement of the system and the damper;  $u_0$  is the replacement range and  $\omega$  is the frequency of excitation. The calculated response force equals:

$$P = P_0 \sin(\omega t + \delta) \quad (3.2)$$

where  $P$  is the response force of the system and the damper;  $P_0$  is the force range; and  $\delta$  is the angle of the phase. The energy depreciated by the dampers equal:

$$W_D = \oint F_D du \quad (3.3)$$

where  $F_D$  is damping force that equals  $C\dot{u}$ ;  $C$  is the damping coefficient;  $\dot{u}$  is the velocity of the system and the damper. Therefore:

$$W_D = \oint F_D du = \int_0^{2\pi/\omega} C\dot{u}^2 dt = Cu_0^2\omega^2 \int_0^{2\pi/\omega} \cos^2 \omega t d(\omega t) = \pi Cu_0^2\omega \quad (3.4)$$

with replacing  $\xi_d = C/C_{cr}$ , we will have the following relation.

$$W_D = \pi Cu_0^2\omega = \pi \xi_d C_{cr} u_0^2\omega = 2\pi \xi_d \sqrt{Km} u_0^2\omega = 2\pi \xi_d K u_0^2 \frac{\omega}{\omega_0} = 2\pi \xi_d W_S \frac{\omega}{\omega_0} \quad (3.5)$$

$C_{cr}$ ,  $K$ ,  $m$ ,  $\omega_0$ ,  $W_S$  respectively display critical damping coefficient, rigidity, mass, natural frequency and the strain energy of the system. Therefore, damping of the damper can be determined through the following relation.

$$\xi_d = \frac{W_D}{2\pi W_S} \frac{\omega}{\omega_0} \quad (3.6)$$

$W_D$  and  $W_S$  are shown in Figure 3. Under earthquake excitations,  $\omega$  equaled  $\omega_0$ , and the above relation is changed as follows.

$$\xi_d = \frac{W_D}{2\pi W_S} \quad (3.7)$$

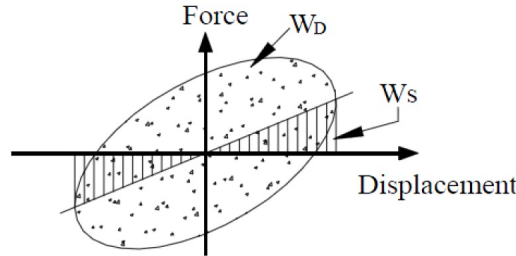

Figure 3:  $W_D$  absorbed energy in a harmonic movement cycle and maximum strain energy of a one-degree-of-freedom system or a damper

Considering the multiple-degree-of-freedom system shown in Figure 4, the effective damping of the entire system is determined using the following relation.

$$\xi_{eff} = \xi_0 + \xi_d \quad (3.8)$$

where  $\xi_0$  is the natural damping of the multiple-degrees-of-freedom system regardless of the dampers; and  $\xi_d$  is the viscous damping of the additional dampers. Expanding the theory of one-degree-of-freedom system, the following relation is used by FEMA273 for introduction.

$$\xi_d = \frac{\sum W_j}{2\pi W_k} \quad (3.9)$$

where  $\sum W_j$  is the overall energy depreciated by the  $j^{th}$  damper of a system in a cycle;  $W_k$  is the elastic strain energy of the frame;  $W_k$  equals  $\sum F_i \Delta_i$  in which  $F_i$  is the story's shear and  $\Delta_i$  is the relative displacement of  $i^{th}$  story. The following relation can determine the energy depreciated by the viscous damper.

$$\sum W_j = \sum \pi C_j u_j^2 \omega_0 = \frac{2\pi^2}{T} \sum C_j u_j^2 \quad (3.10)$$

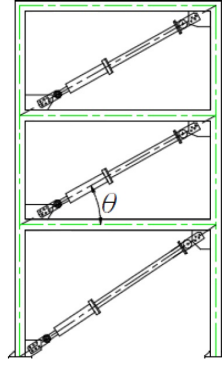

Figure 4: Multiple-degrees-of-freedom of a structure equipped with viscous dampers

where  $u_j$  is the relative axial displacement of the two ends of  $j^{th}$  dampers. According to previous experiences, if the damping of a structure is increased, the impact of higher moods on the response of the structure is reduced. In conclusion, in simplified process of scientific applications solely the first mood of vibration of one-degree-of-freedom system is considered. Using modal strain energy method, absorbed energy and structure's produced elastic strain energy can be written as the following relation.

$$\sum W_j = \frac{2\pi^2}{T} \sum C_j \phi_{rj}^2 \cos^2 \theta_j \quad (3.11)$$

$$W_K = \phi_1^T [K] \phi_1 = \phi_1^T \omega^2 [m] \phi_1 = \sum \omega_i m_i \phi_i^2 = \frac{4\pi^2}{T^2} \sum m_i \phi_i^2 \quad (3.12)$$

where  $[K]$ ,  $[m]$  and  $\phi_1$  are respectively rigidness matrix, concentrated mass matrix and vector of system's first mood.  $\phi_{rj}$  is the relative vertical displacement of  $j^{th}$  damper correspondent to the vector of first mood.  $\phi_i$  is the displacement of the first mood of  $i^{th}$  story.  $\theta_j$  is the angle of placement of  $j^{th}$  damper. Replacing relation (3.9), (3.11) and (3.12) in relation (3.8), the effective damping of the structure and the linear viscous damper are calculated using the following relation.

$$\xi_{eff} = \xi_0 + \frac{\frac{2\pi^2}{T} \sum C_j \phi_{rj}^2 \cos^2 \theta_j}{2\pi \frac{4\pi^2}{T^2} \sum m_i \phi_i^2} = \xi_0 + \frac{T \sum C_j \phi_{rj}^2 \cos^2 \theta_j}{4\pi \sum m_i \phi_i^2} \quad (3.13)$$

How C amounts are distributed in the entire structure is not explained in any of the designing codes. While designing, it is easier to distribute C equally among the stories. However, many empirical results revealed that the outputs of dampers in higher stories are less compared to dampers in the lower stories. A proper distributing method for C amounts is to consider the vertical forces of the dampers in accordance with shear of each story.

## 4 Innovation of the present study

The novelty in using Viscous Dampers regarded in this way that the use of High Capacity Fluid Viscous Dampers is one of the most significant advances of the past 50 years in the seismic protection field, mentioned that They are easy to implement and install, reducing the total cost of the structure. The extant paper attempts to analyze the impacts of viscous dampers on controlling the vibrations imposed on seismic vibrations. In the present study, the impacts of viscous dampers on controlling the vibrations imposed on seismic vibrations are determined using descriptive method [15].

## 5 New buildings design regulations

In the recent years, traditional methods of designing earthquake-resistant buildings have been reconsidered in many countries due to various reasons. The main idea of such reconsiderations is to focus on performance rather than resistance. During the last 70 years in which the methods of designing earthquake-resistant buildings were proposed by regulations, resistance and performance have been generally used in a similar sense. However, during the last 30 years, it was indicated that resistance cannot necessarily lead to increase of security of structures or decrease of damages has changed such attitude [17].

Moreover, these regulations lack the necessary mechanism for controlling buildings at different functional levels. Today, it has been widely accepted that seismic design is not a single stage with a constant and general criterion for all security levels. Generally, preventing a structure collapse and human threats is considered as the minimum security level in all communities. But from a more general point of view, this security level is not enough for a region in which earthquake occurs. In traditional methods of seismic designs, all the mentioned considerations were focused on the amount of coefficients related to base shear design computation. For example, in Iranian regulation 2800, all the mentioned considerations are summarized in a ratio of  $\frac{I}{R}$ , where  $I$  is the importance coefficient and  $R$  is its behavior coefficient. On the basis of innovation of study, it can state that to date large body of studies on dampers effect on seismic vibrations has been proposed, yet just few studies on impact of viscous dampers in controlling vibrations imposed of seismic vibrations have been carried out. Hence, it is essential to carry out necessary studies on effect of these dampers in controlling vibrations.

The single earthquake level determined by design regulations cannot present actual image of seismic capacity and need various security levels through limited tools in order to modify and change them ( $I$  and  $R$  coefficients). The need of considering various objectives with different functional levels in designing buildings has led to many researches and advancements regarding the performance-based designing methods. Conceptually, performance-based designing provides the opportunity for selecting vast functional objectives for engineers and makes designers process the selected objectives and design the building based on an appropriate method to fulfill the selected objectives.

Table 1: The comparison of new buildings design regulations and the current building reinforcing instructions [2]

Type of design	New buildings	Current buildings
Functional levels	Life safety (except than cases that $I > 1$ )	Multiple-level (e.g. the ability of immediate occupancy and life safety and collapse prevention)
Earthquake levels	DBE 1 (MCE 2 for base isolation)	DBE 1 and MCE 2
Change of place and design forces	Decreased ( $R$ coefficient)	Not decreased
Acceptance criteria	Force limitations (resistance)	Limitations of place changing (elastic)

## 6 The impact of various viscous dampers on structures

### 6.1 Fluid viscous damper

Damper tuned liquid system is a passive control method regarding structures' vibrations in which water fluctuations in a tank are used to control structure vibrations. In the beginning of the 20th century, fluid viscous dampers were used to control the vibrations caused by sea waves in ocean-going ships for the first time. Then, in the second half of the 20th century, they were used to control the vibrations caused by free fluctuations and movements with high period in satellite. From the middle of the 1980s, damper tuned liquid was used to control the vibrations of civil engineering structures. Damper tuned liquid is a passive control system applying hydrodynamic forces.

In the damper, some tanks are installed at the top side of the structure. Also, the fluctuation and turbulence of the liquid inside the tanks dissipates the vibration energy imposed to the structure during earthquake or severe winds. The liquid turbulence changes the number of free liquid levels in the bottom walls of the tank and the pressure difference due to the difference in the number of free liquid levels in the bottom walls is appeared in the form of a shearing force at the bottom of the tank. In order to compare the performance of a structure with a damper and without a damper, firstly, with respect to the natural frequency of structure vibrations and using the optimal design of damper, damper tuned liquid is designed for the so called structure. Then, the expected one degree of freedom model was used regardless of the liquid damper under the vibrations of various earthquakes and using Newmark's numerical method of structure response. In the following, by putting some designed dampers on the investigated structure, one degree of freedom model was excited by the so called earthquakes at the presence of damper tuned liquid and like the previous one vibration response of the structure was obtained by using Newmark's numerical method. Finally, the results of the two analyses were compared.

### 6.2 Fluid viscous damper

Dissipating viscous fluid is a solution to increase energy loss of other lateral systems in a structure. In addition to moderating energy, a viscous fluid creates a dissipating pressure leading to power generation through pushing the fluid into the pores. These damping forces are created up to 90% out of the stage of place change production through deriving forces. It means damping forces cannot increase vibrating forces leading to the increase of structure deformation. Adding damping fluid to a structure can increase the dissipating property of a structure above 30% of its

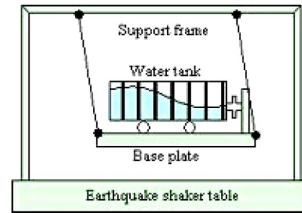

Figure 5: Damper tuned liquid

critical level which is even more in some case. It causes a major reduction in vibrating movements. Adding damping fluid to a structure also decreases the horizontal velocity of the story and increase lateral deformations up to 50% and sometimes even more than 50%.

Figure 6 depicts the viscous damper fluid applied in structures. This fluid has a function similar to the function of impact holders in automobiles but is used at a higher force level. The dampers of structures are significantly larger than self-oriented dampers and are made of steel or other resistant materials ensuring a shell life of at least 4 years. Damper fluid is a kind of static, stable, non-flammable, and non-official silicon oil.

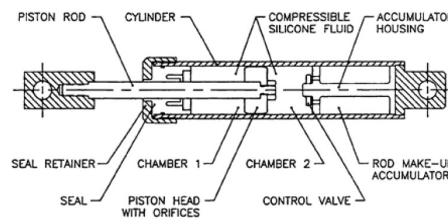

Figure 6: The structure of Fluid viscous damper

The efficacy of the design has been proved during difficult experiments and has been used for more than 40 years in military and commercial sections. Dissipating ability is supplied through a liquid flowing over piston's head. The piston's head is created due to the distance between internal wall of cylinder and external wall of piston's head and makes a circular pore.

Regarding the flow of fluid from the so called pore with a high speed, the performance of the fluid is similar to the performance of the damper impact. The properties of damper are determined by the shape of the piston's head. In this type of dampers, the relation between force and speed can be formulated through the following equation:

$$F = CVXP_N$$

where,  $F$ : external force (based on pound),  $V$ : relative speed of passing through damper,  $C$ : a constant coefficient determined by the diameter of damper and the area of pore,  $N$ : an exponential coefficient with the value between 0.3-1.95. The  $N$  value between 0.3-1 leads to the best structural efficacy. In 1969, viscoelastic damper was used in global trade Centre towers. Therefore, damper has been applied to decrease the vibrations due to the wind. Mahmoodi [11] was of the first researchers investigated the effect of different factors in this type of damper. Afterwards, other researches such as Chen et al. [3] studied the structure equipped with the damper under the impact of earthquake force. Additionally, other models predicting the viscoelastic behavior of damper have been studied including modal strain energy method, ATF/ADF model and GHM model.

As shown in Figure 7, viscoelastic dampers include steel and viscoelastic sheets. Viscoelastic dampers are composed of several steel sheets with elastic and viscous polymer viscoelastic sheets placed between them. Under the impact of displacement excitements, some part of energy is stored in the form of potential energy in viscoelastic substance and the other part is dissipated and disappeared. G1 storage module and G2 loss module explain the properties of the substance.

Viscoelastic dampers have been employed in very high structures in America to decrease the vibrations caused by wind. Decreasing the wind fluctuation is achieved through these dampers in the structures. These dampers are very effective in decreasing the risk of earthquakes in buildings. Many analytical models and numerical methods have been used to simulate the behaviors of viscoelastic dampers. These materials are highly durable, chemically neutral and pollutant-resistant. They are used in dampers in the form of cutting layers with a smaller effective surface relative

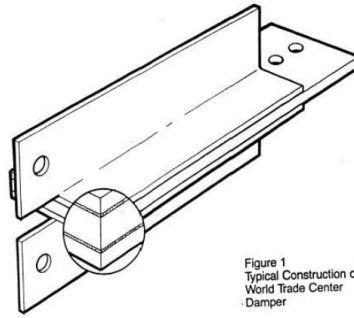

Figure 7: A sample of viscoelastic dampers

to the volume. Hence, each chemical process depends on distribution. For instance, moisture absorption will be very slow. Viscoelastic dampers are totally linear and can dissipate energy at low vibration levels. These dampers decrease the vibration due to the wind, traffic and weak earthquakes. Probably the only weak point of viscoelastic dampers is their different efficacy at different temperatures. Energy is dissipated with the increase of temperature. These dampers have been employed in San Francisco City Hall leading to a 30% decrease in lateral place change.

## 7 Methodology

The present study used a descriptive method to investigate the impacts of viscous dampers on controlling the vibrations imposed on seismic vibrations. To this end, all printed documents such as books, encyclopedias, dictionaries, magazines, newspapers, interviews, articles, internet databases, and etc. were used to gather the required data regarding the related foreign and domestic studies. ETABS software was used for modeling the structures. Also, nonlinear dynamic analysis was used for seismic analysis of the structures.

## 8 Discussion and results

### Damper's equation of motion

To write the equation of viscous dampers' motion, the damper model placed in parallel was considered (Figure 8(a)). In the overall characteristics of the system, two degrees of freedom were considered for each damper. Here, supposing crossed stories, horizontal degree of freedom is transferred to the center of the story mass and changed into a transferring degree of freedom and a spiral degree of freedom (Figure 8(b)).

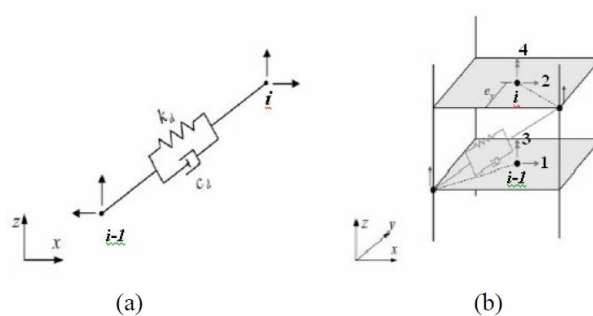

Figure 8: Damper model and the supposition of the crossed diaphragm of stories [8] (a) transferring horizontal degree of freedom to the centre of the story mass, supposing the crossed diaphragm for the stories; (b) spring model-parallel damper for viscous damper

For a damper  $j$  in  $x - z$  plate placed between stories of  $i - 1$  and at the distance of  $(e_{yj})_i$  from the center of the story mass  $i$ , lateral motion of the damper at  $i^{th}$  story will be written based on transferring motion of the center of the story mass in the direction of  $x$  and/or  $(u_x)_i$  and its spiral motion  $(u_\theta)_i$  as follows:

$$(u_{jx})_i = (e_{yj})_i (u_\theta)_i (u_x)_i \quad (8.1)$$



For a damper  $j$  in  $y - z$  plate placed between stories of  $i - 1$  and  $i$  at the distance of  $(e_{jx})_i$  rom the center of the story mass  $i$  will be written based on transferring motion in the direction of  $y$  and/or  $(u_y)_i$  and its spiral motion  $(u_\theta)_i$  as follows:

$$(u_{jy})_i = (e_{xy})_i(u_\theta)_i(u_y)_i \quad (8.2)$$

Thus, with respect to the above definitions, hardness and damping matrix of viscous damper can be obtained as follows [8]:

$$[K_{Dj}] = K_{dj} \begin{bmatrix} \cos^2 \alpha & -\cos^2 \alpha & (e_{yi})_{i-1} \cos^2 \alpha & -(e_{yi})_i \cos^2 \alpha \\ -\cos^2 \alpha & \cos^2 \alpha & -(e_{yi})_{i-1} \cos^2 \alpha & (e_{yi})_i \cos^2 \alpha \\ (e_{yi})_{i-1} \cos^2 \alpha & -(e_{yi})_{i-1} \cos^2 \alpha & (e_{yi})_{i-1}^2 \cos^2 \alpha & -(e_{yi})(e_{yi})_{i-1} \cos^2 \alpha \\ -(e_{yi})_i \cos^2 \alpha & (e_{yi})_i \cos^2 \alpha & -(e_{yi})_{i-1}(e_{yi})_i \cos^2 \alpha & (e_{yi})_i^2 \cos^2 \alpha \end{bmatrix}$$

$$[C_{Dj}] = C_{dj} \begin{bmatrix} \cos^2 \alpha & -\cos^2 \alpha & (e_{yi})_{i-1} \cos^2 \alpha & -(e_{yi})_i \cos^2 \alpha \\ -\cos^2 \alpha & \cos^2 \alpha & -(e_{yi})_{i-1} \cos^2 \alpha & (e_{yi})_i \cos^2 \alpha \\ (e_{yi})_{i-1} \cos^2 \alpha & -(e_{yi})_{i-1} \cos^2 \alpha & (e_{yi})_{i-1}^2 \cos^2 \alpha & -(e_{yi})(e_{yi})_{i-1} \cos^2 \alpha \\ -(e_{yi})_i \cos^2 \alpha & (e_{yi})_i \cos^2 \alpha & -(e_{yi})_{i-1}(e_{yi})_i \cos^2 \alpha & (e_{yi})_i^2 \cos^2 \alpha \end{bmatrix}$$

Having hardness and damping matrix of a damper, the following equation of motion is obtained [8]:

$$[M_D]\{\ddot{u}_D\} + [C_D]\{\dot{u}\} + [K_D]\{u\} = \{F_D\} \quad (8.3)$$

In this equation, mass matrix of damper can be ignored due to the small value of the damper mass.

#### Adding the damper's equation of motion to the equation of the structure's motion

Disregarding mass matrix of the damper which is very slight compared to mass matrix of the structure, its hardness and damping matrices are respectively added to hardness and damping matrices of the structure. To do so, the elements of damper's hardness and damping matrices are added respectively to the corresponding elements of the structure's hardness and damping matrices, (Figure 9).

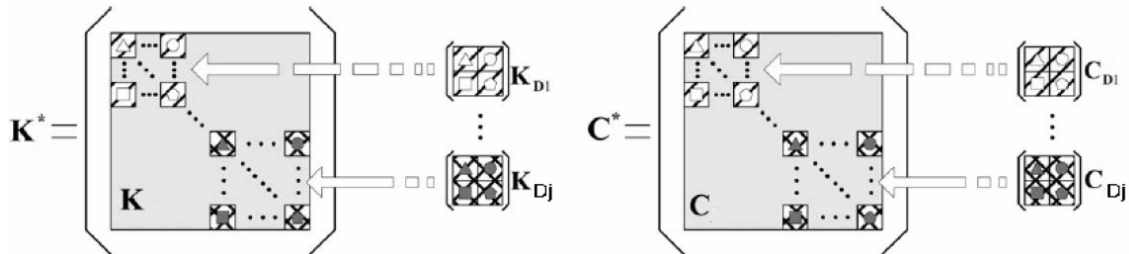

Figure 9: Adding damper's hardness and damping matrices to structure's hardness and damping matrices [8]

Therefore, the structure's hardness and damping matrices are obtained with the presence of passive viscous damper which are respectively called  $[K^*]$  and  $[C^*]$ . Having the above matrices, the structure's equation of motion with the presence of the damper can be stated as follow:

$$[M]\{\ddot{u}\} + [C^*]\{\dot{u}\} + [K^*]\{u\} = -[M]\{r\}\ddot{u}_g(t) \quad (8.4)$$

#### Determining damping ration obtained from viscous damper's attachment

In multi-story building frames, under the proper conditions (elasticity, uniform distribution of damping in the height of the frame, clear effective damping and vibrating modes, and the dampers' arrangement), the attached damping ration in  $m^{th}$  mode can be determined using the following equation [14].

$$\beta_{vm} = \frac{T_m}{4\pi} \cdot \frac{\sum_{i=1}^n C_i f_i^2 \varphi_{ri}^2}{\sum_{i=1}^n \frac{W_i}{g} \varphi_{im}^2} \quad (8.5)$$

where  $T_m$ : The  $m^{th}$  period of the building with attached viscous damper,  $W_i$ : Weight of each story,  $C_i$ : damping coefficient of each  $i^{th}$  damper,  $\varphi_m$ :  $m^{th}$  vibrating mode,  $f_i$ : Damper's arrangement coefficient (Which is  $f_i =$

$\cos \vartheta$ , considering the damper's diagonal installation in the frame) and ( $\varphi_{ri} = \varphi_{im} - \varphi_{(i-1)m}$ ) and  $\beta_{vm}$ : the ratio of damping due to the attached damper in  $m^{th}$  mode.

In equation (8.5),  $C_i$  can be obtained by considering the ratio of various damping resulted from the attached damper but in accordance with the FEMA-356 regulations. In case of nonlinear dynamic analyses, the value of  $T_{ss}$  is replaced with the value of  $T_m$  in equation (8.5) and its value equals to  $T_{ss} = T_e \sqrt{\frac{k_e}{k_s}}$ . Figure 10 shows the computation of the value of  $T_{ss}$  with respect to the FEMA-356 regulations.

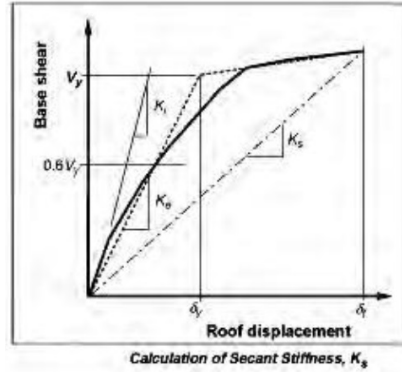

Figure 10:  $T_{ss}$  value computation [14]

Table 2: Determining the value of B coefficient based on the structure's damping ration

Effective damping, $\beta_{eff}$	$B_s$	$B_l$
< 2%	0.8	0.8
5%	1.0	1.0
10%	1.3	1.2
20%	1.8	1.5
30%	2.3	1.7
40%	2.7	1.9
> 50%	3.0	2.0

To determine the value of  $T_{ss}$ , structure's pushover curve was drawn based on FEMA-356 seismic instructions. Considering how results are influenced by the pattern of selected loadings, uniform loading and spectral loading were used for drawing it. Then, the maximum amount of  $T_{ss}$  resulted from the two types of loading distribution were determined based on the pushover curve and changing it into two lines based on FEMA-356 regulations.

Table 3: The impact of the length of joint on the stiffness of EBFs

$\frac{e}{L}$	0	0.5 < 0	0.5 > 0	1
Range of stiffness	The frame has the maximum of stiffness (CBF).	Braces have a great impact on the stiffness of the frame.	The stiffness caused by the braces is low.	The frame has the minimum level of stiffness. (Equal to MRF)

The main period of EBF is another factor influenced by the length of the joint. Considering this fact, we can hinder the accordance of the main period of the structure with the earthquake period of the area. The length of the joint has impacts on lateral stiffness of the structure and the resistance of EBFs. Reduction in the length of the joint causes increase in the resistance of EBF. The lateral resistance of an EBF with short joint can be 4.5 to 9 times more than the lateral resistance of a MRF.

Table 4: Seismic parameters of five-story frame

$\frac{e}{L}$	$T_e$ (sec)	$V_y$ (KTON)	$V_s$ (KTON)	$R_{SO}$	$R_S$	$\mu$	$\phi$	$R_\mu$	$R_u$	$R_w$
0.15	1.07	0.376	0.362	1.04	1.19	2.03	0.73	2.60	3.11	4.35
0.2	1.07	0.4	0.312	1.28	1.47	2.18	0.73	2.21	3.26	4.56
0.25	0.74	0.340	0.265	1.28	1.48	2.25	0.81	2.54	3.75	5.25
0.3	0.8	0.290	0.249	1.16	1.34	2.33	0.78	2.92	3.92	5.48

According to the tables, behavior coefficient of fifteen-story EBF is about 6.5-7.75. This parameter is reduced with the decrease in the number of stories. For five-story frames, increase in the length of the joint causes a bigger

Table 5: Seismic parameters of five-story frame

$\frac{e}{L}$	$T_e$ (sec)	$V_y$ (ton)	$V_s$ (ton)	$R_{SO}$	$R_S$	$\mu$	$\phi$	$R_\mu$	$R_u$	$R_w$
0.15	1.88	0.679	0.573	1.18	1.36	2.14	0.91	3.35	4.56	6.66
0.2	2.05	0.611	0.428	1.43	1.64	2.31	0.94	3.24	5.32	7.76
0.25	1.79	0.917	0.610	1.50	1.73	3.38	0.89	2.55	4.41	6.45
0.3	1.876	0.972	0.572	1.70	1.95	3.21	0.91	2.33	4.55	6.65

behavior coefficient. However, in tall frames the biggest behavior coefficient occurs in average length of the joint. About plasticity, it can be stated that in all the frames bigger ratio of  $e/L$  have more plasticity. However, the greatest level of plasticity occurs in fifteen-story frames. As shown in Figure 11, with increase in the length of the joint, the obtained behavior coefficients for all the stories are about the fixed value (approximately the behavior coefficient suggested by 2800 regulations).

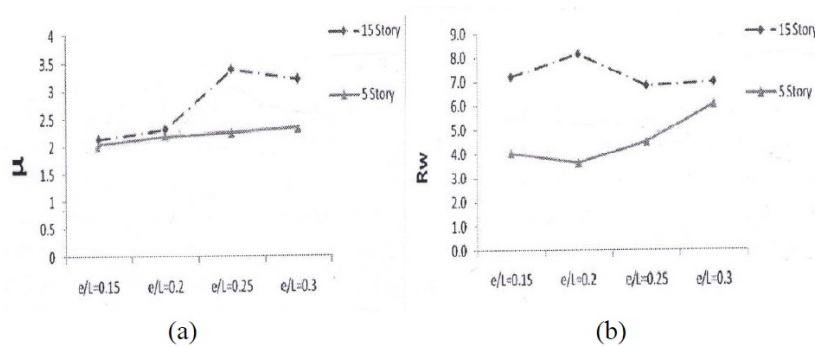

Figure 11: (a) Changing curve (b) Behavior coefficient. Plasticity for discussed frames

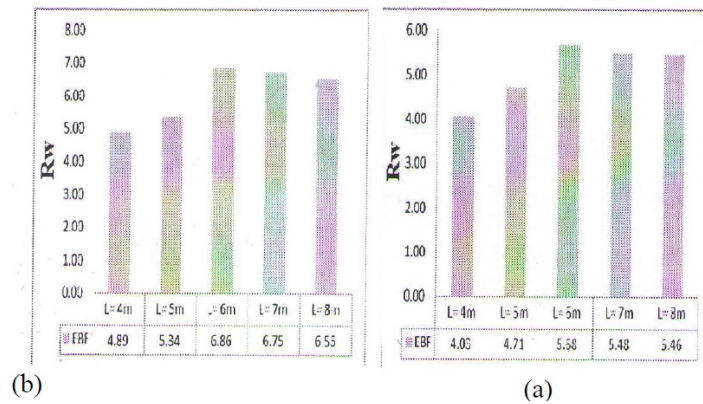

Figure 12: Behavior coefficient corresponding to different lengths. (a): five story frames, (b): fifteen story frames

Considering the above figures, the length of the bray does not have an impact on the behavior coefficient of these frames. Unlike the moment frames and some other systems, in these systems, the fixed  $e/L$  ratio of behavior coefficient does not change drastically.

According to the above figures, increase in  $e/L$  ratio causes increase in total dissipation of energy. However, the amount of increase is not the same for all the frames, and even in some cases it has the opposite effect. In general, extreme increase in the length of the joint causes decrease in dissipation of energy; and subsequently causes a sharp decline in lateral resistance of the structure; and then it brings about decrease in structure’s power for energy dissipation. It is obvious that more changes happen in frames with less number of stories. Generally, it can be concluded that the taller joints absorb more energy, though their length should not be taller than a specific amount. Otherwise the amount of absorbance will be reduced due to sharp decline in the stiffness.

Using MATLAB software, a program has been written for calculating the lateral displacement and shears of structures with linear viscous dampers, with three frame 5-story, 8-story and 10-story modeling that are completely described in the following. The impact of dampers in reduction of lateral displacement and shear of the stories has

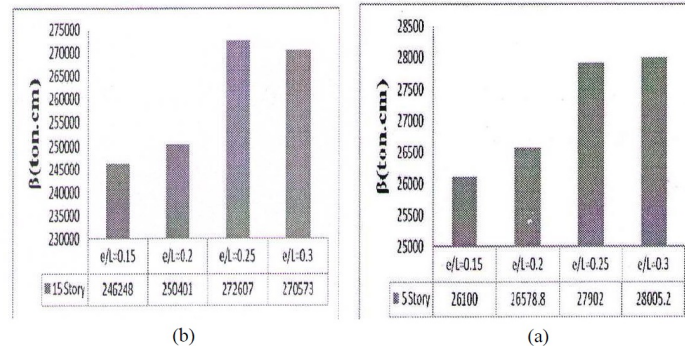

Figure 13: Behavior coefficient corresponding to different lengths. (a): five story frames, (b): fifteen story frames

been studied.

Studied structures are located in areas that are highly prone to earthquakes; and the type of the soil is one according to 2800 standard. Residential frames are assumed to have average significance index.

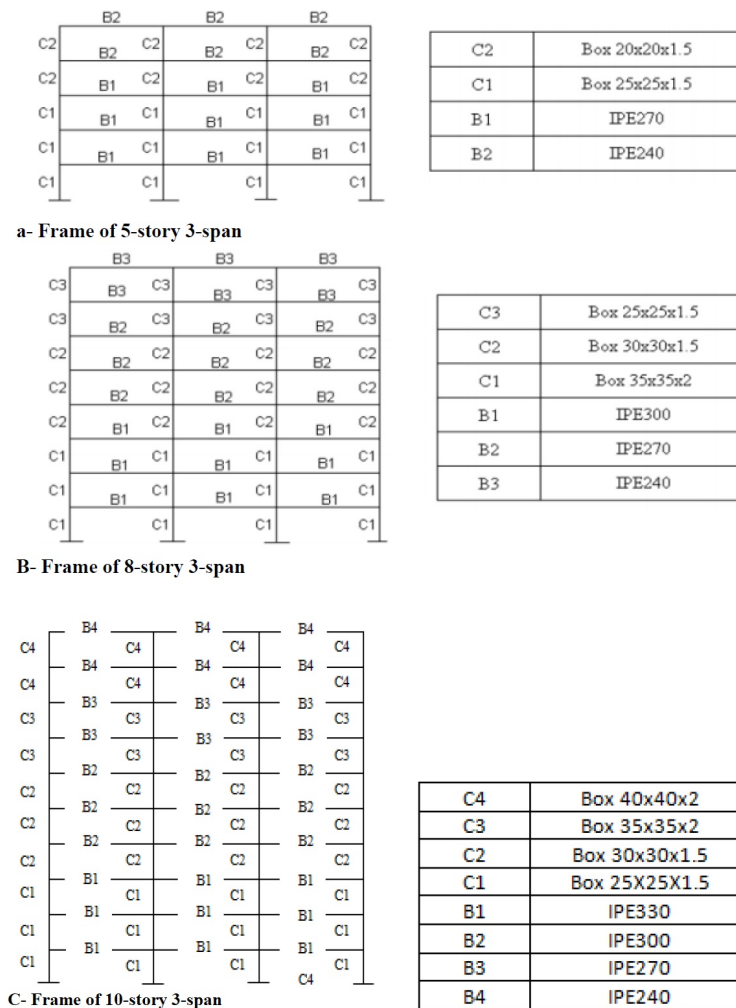

Figure 14: Modelling details

Calculating the mass matrix, rigidness of the frames, assuming the natural damping as 5% and viscous damping as 15% for the frames (a viscous damper is used in each story), and entering the data into the program, the following results have been obtained.

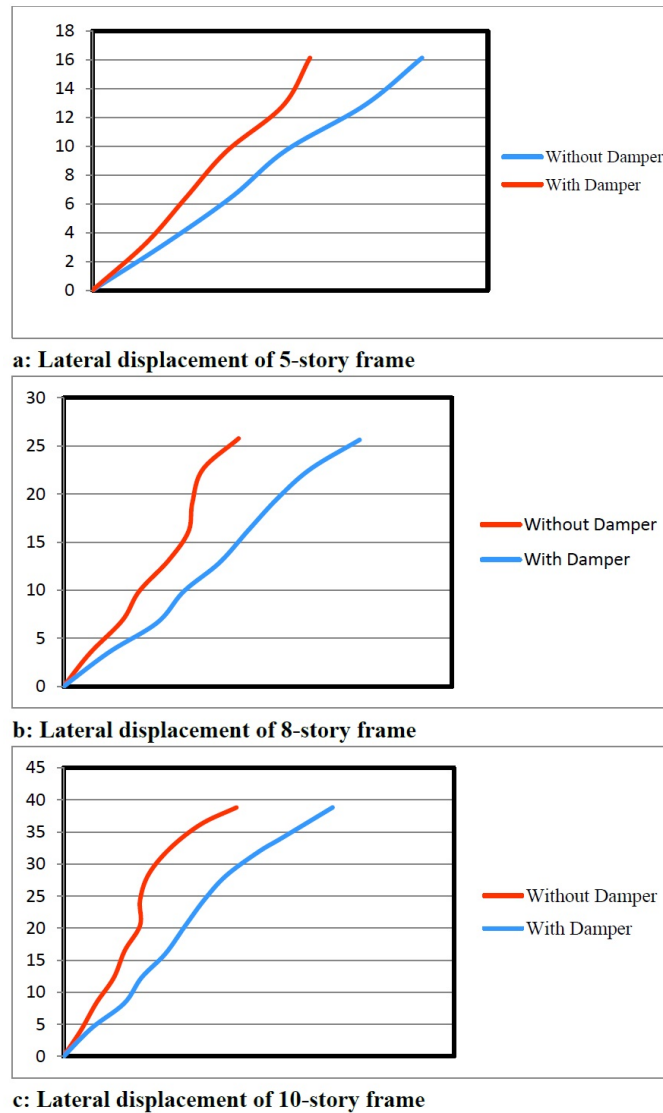

Figure 15: Lateral displacement of 5-story frame, 8-story frame and 10-story frame

As observed in the diagram, lateral displacement of the stories in 5-story, 8-story and 10-story frames are respectively reduced 33%, 42% and 49% that shows viscous dampers have more impacts in higher structures.

## 9 Conclusion

The extant research studied the impact of viscous dampers in EBFs on the earthquakes in areas near the fault or far from it. There was a significant relation between passive viscous dampers and decrease in structures' seismic response at the confidence level of 90%. Reduction of energy of structure hysteresis because of the nonlinear behavior of members using dampers is proved to be significant at the confidence level of 80%. Therefore, these dampers can be used for retrofitting the present structures or making them Lightweight. The results reveal that benefiting from viscous dampers improves the seismic parameters of the structure and enables reduction of replacement, speed, floor acceleration and base shear. Considering the presented discussion, the following conclusions can be stated: Damping coefficient of viscous dampers depends highly on the frequency, and range of the imposed load. Also, it is necessary to calibrate the coefficient determined in damper test with respect to these factors as compared to the theoretical results. Considering the fact that viscoelastic dampers depend on the frequency of inlet excitations, using these dampers in the structure increases damping of high modes. From this perspective, using these dampers in high structures is superior to other energy absorption systems. Increasing damping can decrease the structure's response to a specific extent in an appropriate way. Besides that, increasing damping cannot have any significant effect in the structure's response.

This specific extent depends on the characteristics of the structure, especially on its height in a way that the optimal values are decreased by increasing the height. Dampers containing fluid viscous damper of energy can strengthen buildings and their performance during severe earthquakes while they can be used in newly constructed or constructed structures. These dampers are good alternatives for base separation method due to their low cost, easy installation and implementation. Furthermore, the results reveal that the lateral resistance of an EBF with short joint can be 4.5 to 9 times more than the lateral resistance of a MRF, that behavior coefficient of fifteen-story EBF considered 6.5-7.75, concluded that the length of the bray does not have an impact on the behavior coefficient of these frames.

## References

- [1] K.R. Asfar and S.N. Akour, *Optimization analysis of impact viscous damper for controlling self-excited vibrations*, J. Vib. Cont. **11** (2005), no. 1, 103–120.
- [2] T.-Y. Chen, *A meta-analysis of effectiveness of computer-based instruction in mathematics*, The University of Oklahoma, 1994.
- [3] F.Y. Cheng, H. Jiang and K. Lou, *Smart structures: innovative systems for seismic response control*, CRC Press, 2010.
- [4] M.C. Constantinou and M.D. Symans, *Experimental and analytical investigation of seismic response of structures with supplemental fluid viscous dampers*, Technical Report NCEER-92-0032, National Center for Earthquake Engineering Research, Buffalo, New York, 1992.
- [5] S. El-Borgi, H. Smaoui, F. Casciati, K. Jerbi and F. Kanoun, *Seismic evaluation and innovative retrofit of a historical building in Tunisia*, J. Struct. Control Health Monitor. **12** (2005), no. 2, 179–196.
- [6] S. Infanti and M.G. Castellano, *Viscous dampers: a testing investigation according to the HITEC protocol*, Proc. Fifth World Cong. Joints Bear. Seismic Syst. Concrete Struct., Rome, Italy, 2001.
- [7] J. Jiuhong, D. Jianye, W. Yu and H. Hongxing, *Design method for fluid viscous dampers*, J. Arc. Appl. Mech. **78** (2008), 737–746.
- [8] S.H. Lee, K.W. Min, J.S. Hwang and J. Kim, *Evaluation of equivalent damping ratio of a structure with added dampers*, J. Eng. Struct. **26** (2004), 335–346.
- [9] T.K. Lin, C.C. Chen, K.C. Chang, C.C.J. Lin and J.S. Hwang, *Mitigation of micro vibration by viscous dampers*, J. Earthq. Eng. Eng. Vib. **8** (2009), 569–582.
- [10] D. Lopez Garcia, *A simple method for the design of optimal damper configurations in MDOF structures*, J. Earthquake Spectra **17** (2001), no. 3, 387–398.
- [11] P. Mahmoodi, *Structural dampers*, Journal of the Structural Division, 95 (1969), no. ST8, 1661–1672.
- [12] M.R. Mansoori and A.S. Moghadam, *Using viscous damper distribution to reduce multiple seismic responses of asymmetric structures*, J. Construct. steel Res. **65** (2009), 2176–2185.
- [13] A. Occhiuzzi, *Additional viscous dampers for civil structures: analysis of design based on effective evaluation of modal damping ratios*, J. Eng. Struct. **31** (2009), 1039–1101.
- [14] O.M. Ramirez, M.C. Constantinou, A.S. Whittaker, C.A. Kircher, M.W. Johnson and C.Z. Chrysostomou, *Validation of the 2000 NEHRP provisions' equivalent lateral force and modal analysis procedures for buildings with damping systems*, Earthquake Spectra **19** (2003), no. 4, 981–999.
- [15] A.S. Vader, *The influence of signature tower passive energy dissipating devices on seismic response of long span cable-supported bridges*, Thesis, Washington State University, 2004.
- [16] Z. Xu, A.K. Agrawal, W.L. He and P. Tan, *Performance of passive energy dissipation systems during near-field ground motion type pulses*, J. Eng. Struct. **29** (2007), 224–236.
- [17] A. Whittaker and M.C. Constantinou, *Fluid viscous dampers for building construction*, First Int. Symp. Passive Control, 2000, pp. 133–142.