



## Soft Story Design of Reinforced Concrete Structures with Masonry Infill walls

Seyed Mojtaba Hosseini Gelekolai<sup>1</sup> , Mohammad Reza Tabeshpour<sup>2\*</sup>

1. Department of Civil Engineering, Sharif University of Technology, Tehran, Iran

2. School of Mechanical Engineering, Sharif University of Technology, Tehran, Iran

Corresponding author: [tabeshpour@sharif.edu](mailto:tabeshpour@sharif.edu)

### ARTICLE INFO

#### Article history:

Received: 15 May 2023

Revised: 02 July 2023

Accepted: 07 July 2023

#### Keywords:

Soft story;

Masonry infill wall;

Seismic design;

Concrete structures;

Overstrength factor.

### ABSTRACT

Based on the seismic design codes to prevent soft-story failure, columns of a soft story must be designed for amplified loads due to the discontinuity of braces or shear walls in that story. Because of the masonry infill walls discontinuity, Soft story failure has been reported in the recent earthquakes. Most national seismic design codes don't consider the effect of masonry infill walls for the design of the soft story. This paper aims to investigate the soft story failure and then present a simple formula for the design of soft-story in moment resisting frame structures. In this paper, the different arrangements of masonry infill walls are considered. Structural modeling was carried out based on reliable parameters and some national or international seismic design codes. By using nonlinear static analysis, a simple methodology is proposed and the main result is a simple formula that can be used for the engineering design of concrete moment resistant frames.

## 1. Introduction

Masonry infill walls exist in several buildings but their role in the rehabilitation and retrofitting of the structures is neglected by most structural engineers. Research on the behavior of frames with masonry infill walls has been started in the 1950s. Several lateral loading tests have been done on the full-scale and prototype models including masonry infill walls. The material property of the frames was almost reinforced concrete or

steel and infill materials consist of bricks, concrete blocks (reinforced or not), or reinforced concrete. The main effective parameters in the behavior and failure modes of the frames with masonry infill walls are strength, stiffness, hysteresis energy dissipation factor, the boundary condition of the infill, distributions of strain and stress inside masonry infill walls, applied load to the frame, existence of openings and the manner of construction [1]. There are two general methods for considering the effects

#### How to cite this article:

Hosseini Gelekolai, S. M., & Tabeshpour, M. R. (2023). Soft Story Design of Reinforced Concrete Structures with Masonry Infill Walls. *Journal of Rehabilitation in Civil Engineering*, 11(4), 122-137.

<https://doi.org/10.22075/jrce.2023.30956.1868>

of masonry infill walls in structural frames in the seismic design of structures [2]:

- Modeling the infill separately and neglecting the interaction of masonry infill walls in the structural response
- Coupled modeling of masonry infill walls and structural frames considering the interaction of infill and structural frame

In the second procedure, there is the possibility of impacting frames by infill during an earthquake, leading to a great number of shears and bending moments in the columns and forming a short column mechanism [3]. In this case, shear failure in the concrete structures is possible [4]. In many countries, buildings are usually designed without considering the effects of infill walls on the seismic behavior of the structure. But it was observed that the infill increases the strength and stiffness of the frames and consequently leads to a change in the seismic behavior of the frames. Considering the importance of the topic, it is necessary to study the changes in the seismic behavior of the structures due to the interaction of infill walls and the structural frame. Several good designed structures in the past earthquakes neglected the effect of infill interaction leading them to severe damage [5,6]. The main negative effects of the infill walls in the structures are the followings:

- Soft story failure (height irregularity)
- Torsion (plan irregularity)
- Short column (reinforced concrete structures)

Masonry walls are commonly used in many countries (especially Asian countries like Iran) in the construction of buildings both as infill or partition walls. It is important from

structural and architectural points of view to consider the effects of masonry infill walls in the design and retrofit of the structures [7].

Some of the national building codes have requirements for the design of the columns of the soft stories. There are different points of view in the design of beams, columns, and connections of the soft story in these codes. In many national building codes, there are no clear requirements for the design of soft-story due to the removal of masonry infill walls [8].

A relatively complete review of the seismic behavior of masonry infills and design of infilled frames is presented by Tabeshpour. Tabeshpour has investigated several seismic guideline of considering masonry infill walls in order to compare them for seismic design [6–8]. He has presented the requirements and necessities of infilled frames from building code approaches and engineering applications. Tabeshpour et al. conducted research about drift of concrete structures with masonry infill walls to know if separating the infill wall from the structure is more proper or not? [9]

Tabeshpour et al conducted a study to analyze the impact of masonry infills on the seismic behavior of concrete frames [9]. They considered different types of infill arrangements. The study revealed that a significant amount of drift occurs in the soft story [10], which is the story without any infill. Designing columns in soft stories is crucial to ensure a satisfactory response during severe earthquakes [11].

In order to prevent soft-story failure, columns should be designed for increased loads. Tabeshpour has conducted researches how increasing design load in specific columns can help a building resist failures [6–9].

Because of significant variations in material properties and failure modes that are brittle, it's difficult to predict the masonry infill wall's behavior [12]. As a result, masonry infills have often been treated as nonstructural elements in buildings, and their effects were not included in the analysis and design procedure. However, experiences show that masonry infills may have significant positive or negative effects on the global behavior of buildings therefore, it should be addressed appropriately.

For example, the Iranian Building Code (Standard No. 2800) recommends not discontinuing any lateral load-resisting element in the structure but if this criterion is not satisfied, it is recommended to increase the design loads of the structure to the followings [13,14]:

- Dead Load + 0.8 Live Load  $\pm$  2.8 Earthquake Load
- 0.85 Deal Load  $\pm$  2.8 Earthquake Load

The strength of these columns doesn't need to be more than the maximum load that could be transferred by connected elements to the columns. The above resistance for columns is their ultimate strength of them. In the columns designed based on allowable stress design (ASD), this resistance is considered 1.7 times the allowable resistance of the columns. It is notable that in the case of discontinuity of masonry infill walls the above load combination must be imposed, otherwise the soft story failure will occur. In the combination above, the only change is multiplying the earthquake load by an overstrength factor that here the Building Code suggests to be 2.8, in this research we will obtain a formula for predicting the overstrength factor.

## 2. Modeling Procedure and Concepts

The idea of using a single element to model the infill wall was always interesting because of having many advantages in the analyzing procedure [15]. A diagonal strut with proper mechanical behavior can be a good alternative for modeling infill walls [16]. here in this study masonry infill are considered as an equivalent compressive strut, which are diagonal and link the joints of the frames with length equal to diameter of the frame and width of 0.2 times of this value. The thickness of the strut is equal to the thickness of the wall (Fig.1) [6].

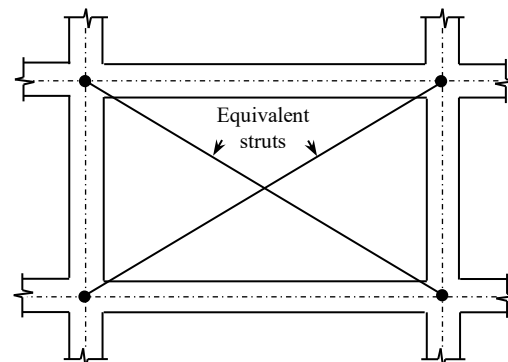
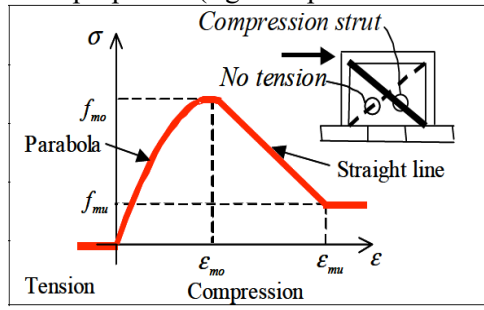

**Fig. 1.** Description Coupled Equivalent compressive strut.

The proposed effective width of the equivalent strut is extremely scattered in the range of 0.1 to 0.35 times frame diameter. To obtain material properties of masonry struts, the Australian Code is used with consideration of the usual mortar and bricks of Iran [17] [18]. The following stress-strain curve is for two kinds of infill walls (17 cm and 23 cm respectively), obtained from the Australian Code. The stress-strain curve of masonry material in compression is in the shape of a parabolic curve till maximum stress  $f_{mo}$  then it decreases linearly after that remains constant (Table1) [19].

**Table 1.** Equivalent masonry strut's material properties (figure reproduced from [20]).

	Thickness 17 (cm)	Thickness 23 (cm)
$f_{mo}$ (MPa)	3.68	4
$\epsilon_{mo}$	0.0014	0.0014
$f_{mu}$ (MPa)	0.736	0.8
$\epsilon_{mu}$	0.0028	0.0028



To consider the effect of existing openings, New Zealand Code's equation is used in which a reduction factor for the width of the strut is considered [17]:

$$\lambda_{opening} = 1 - 1.5 \times \left( \frac{L_{opening}}{L_{infill}} \right) \quad (1)$$

In the above equation,  $\lambda_{opening}$  is the effective width reduction factor,  $L_{Opening}$  is the length of the opening in the horizontal direction and  $L_{infill}$  is the total length of the infill wall in the horizontal direction. The reduction factor  $\lambda_{opening}$  equals 0.5 when there is a 33% opening in the infill wall and equals 0 when there is a 67% opening in the infill wall [21].

### 3. Modeling of elements

OpenSees software is used to implement the static nonlinear analysis (pushover) [22]. NonlinearBeamColumn elements with fiber section are used to model RC elements; in this case, elements are divided into longitudinal fibers. First, the stress-strain relations for each fiber are determined and

then force deformation relations for each section are obtained by integration of the stress-strain curve of section fibers. This integration is based on the assumption of small planner deflection theory without distortion. By using fiber sections and assigning them to NonlinearBeamColumn elements, distributed plasticity is considered all over the elements' length. According to Gauss-Lobatto's method, seven integration points are used in the length of elements with two points at the beginning and end of elements. For concrete properties, Concret01 material which is a uniaxial material with considering stiffness degradation linearly in loading and unloading is used [23,24]. Effects of concrete confining are considered by Mander et al.'s research for elements' core (Table 2). For core concrete because of confinement 28 day strength of the concrete is considered 28 MPa, the ultimate strength of the concrete under ultimate load is considered 20% of the 28 day strength. For cover concrete the 28 day strength is considered 24 MPa.

**Table 2.** Stress-strain curve of concrete fiber section [25].

	$f_{mo}$ (MPa)	$\epsilon_{mo}$	$f_{mu}$ (MPa)	$\epsilon_{mu}$
Core	28	0.0024	5.6	0.015
Cover*	24	0.002	4.8	0.005

\*for beams is equal to 4 cm from each edge of the section  
\*for columns is equal to 4.5 cm from each edge of the section

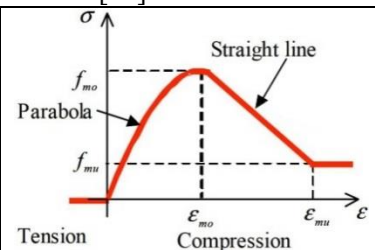

Rebars are modeled with steel02 material which is a uniaxial material with hardening based on Menegotto-Pinto's (1973) equations

[26]. In this research,  $E_0$  equals  $2 \times 10^{11}$  (Pa), yielding stress equals  $4 \times 10^8$  (Pa) and  $b$  equals 1% (Fig.2) [24].

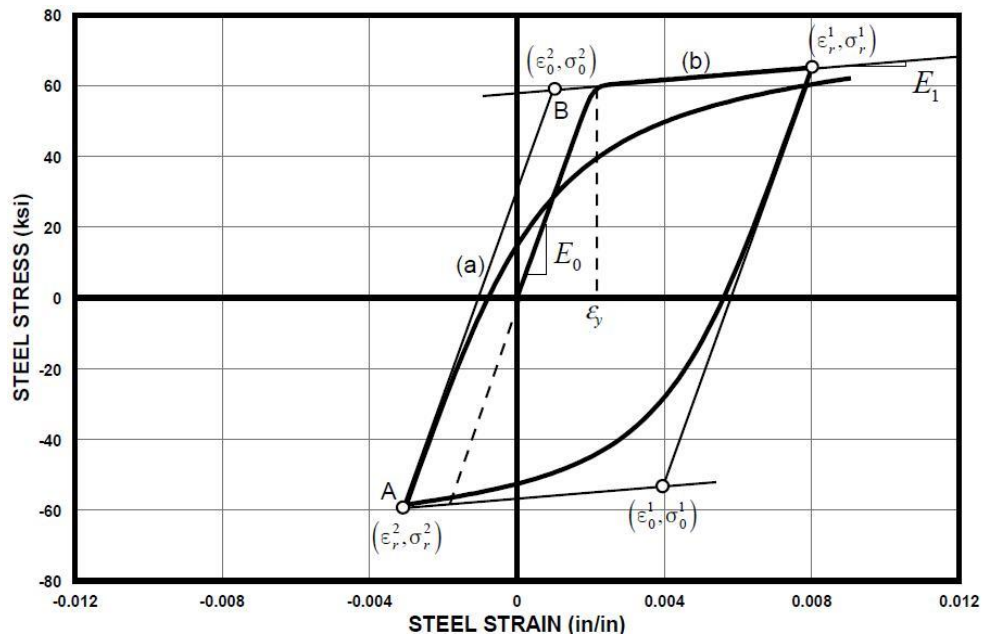

Fig. 2. Menegotto-Pinto Stress-strain curve for steel [26].

#### 4. Model Description

In this study, three types of frames with 3, 5, and 9 stories tall with 3 bays are investigated. Lengths of bays are equal to 5.5 (m) and story heights are 3 (m) except 3.5 (m) for the first story. Fig.5 shows the plan of the building. Arrangements of infill walls are categorized into 12 cases in general: middle bay, two side bays, and all three bays, each one with two types of walls with a thickness of 17 (cm) and 23 (cm) and with two cases of existence of 33% opening or without opening (Fig.3). The lateral force resisting system is an intermediate moment frame and the type of soil is considered as II (medium) [27].

Since investigating the effects of masonry infill walls was the main goal of this research, the considered frames were designed according to the last version of

Iranian Building Codes without considering infill walls and the equivalent static lateral load pattern method used for the design of structures [28,29]. the design sections for 3 story frame are shown in Table 3 and Fig.4, the design sections for 5 story frame are shown in Table 4 and Fig.6, the design sections for 9 story frame are shown in Table 5, Fig.6 (transverse reinforcement in columns considered as #10@100 mm closed stirrups).

Dead and live loads of stories were considered 600 (kg/m<sup>2</sup>) and 200 (kg/m<sup>2</sup>) respectively. These parameters were considered 550 (kg/m<sup>2</sup>) and 150 (kg/m<sup>2</sup>) respectively for the roof story. Dead loads were considered 100 (kg/m<sup>2</sup>) and 133 (kg/m<sup>2</sup>) for 17 (cm) and 23 (cm) thick walls respectively (This paper is part of M.Sc. Thesis of S.M. Hosseini Gelekolai [6]).

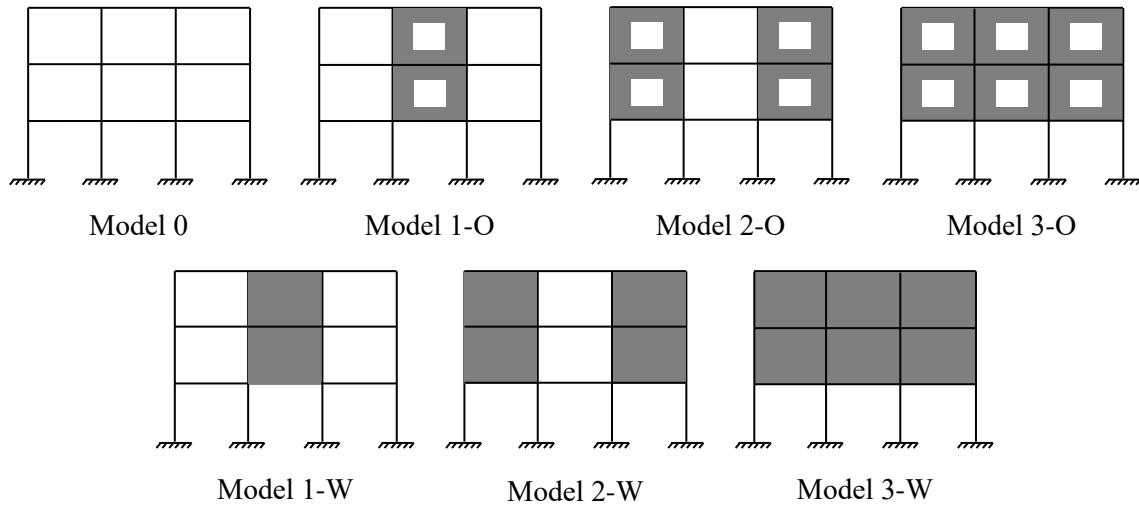

**Fig. 3.** Naming different models of existing masonry infill walls in 3 story building and wall thickness of 17 (cm) (O: 1/3 opening, W: without opening) [6].

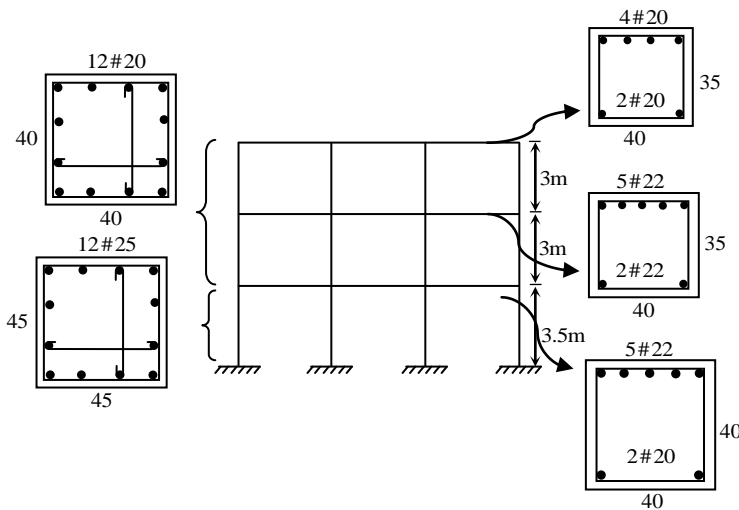

**Fig. 4.** Three-story Frame elevation view.

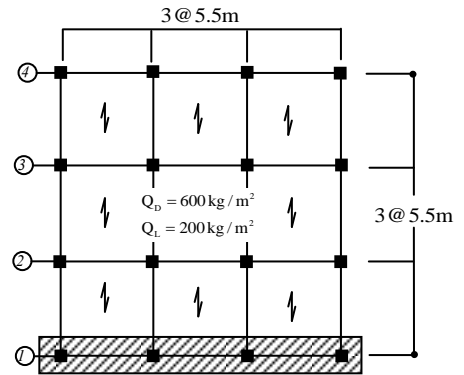

**Fig. 5.** Building's plan.

**Table 3.** Detail of Sections in 3 story frame.

Story	Column		Beam		
	Rebar ‡	Dimension †	Bottom Reba	Top Rebar	Dimension
1	12 # 25	45 × 45	2 # 22	5 # 22	40 × 40
2	12 # 20	40 × 40	2 # 22	5 # 22	40 × 35
3	12 # 20	40 × 40	2 # 20	4 # 20	40 × 35

† Dimension in cm (width × height)

‡ Number of Rebar # Rebar Diameter in mm

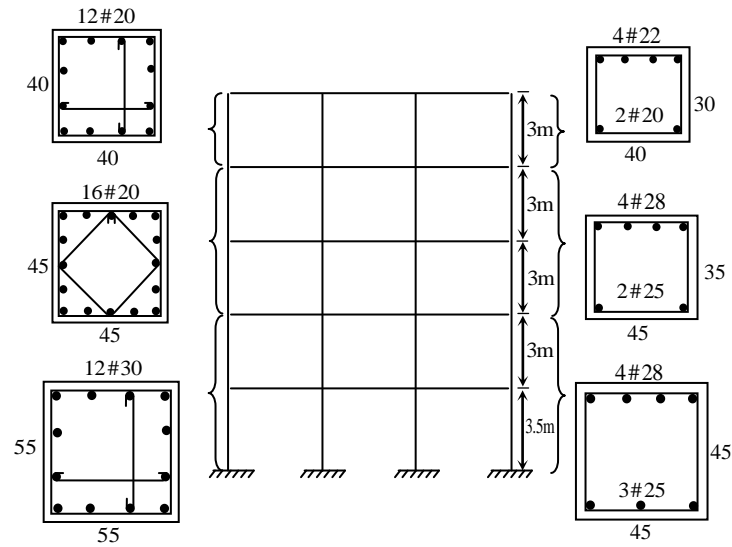

Fig. 6. Five-story Frame elevation view.

Table 4. Detail of Sections in 5 story frame.

Story	Column		Beam		
	Rebar ‡	Dimension †	Bottom Rebar	Top Rebar	Dimension
1,2	12 # 30	55 × 55	3 # 25	4 # 28	45 × 45
3,4	16 # 20	45 × 45	2 # 25	4 # 28	45 × 35
5	12 # 20	40 × 40	2 # 20	4 # 22	40 × 30

† Dimension in cm (width × height)

‡ Number of Rebar # Rebar Diameter in mm

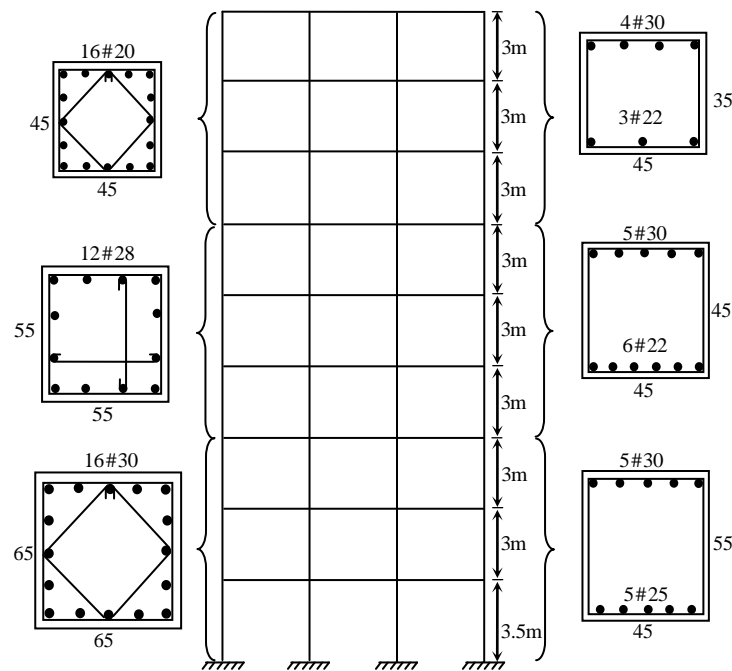

Fig. 7. Nine story Frame elevation view.

**Table 5.** Detail of Sections in 9 story frame.

Story	Column		Beam		
	Rebar ‡	Dimension †	Bottom Rebar	Top Rebar	Dimension
1,2,3	16 # 30	65 × 65	5 # 25	5 # 30	45 × 55
4,5,6	12 # 28	55 × 55	6 # 22	5 # 30	45 × 45
7,8,9	16 # 20	45 × 45	3 # 22	4 # 30	45 × 35

† Dimension in cm (width × height)

‡ Number of Rebar # Rebar Diameter in mm

### 5. Determining of Overstrength Factor

To determine the overstrength factor  $\alpha$  for the first story column, the trial and error method is used, in this method dimension of the first story column in the direction of the frame will increase by 2.5 cm increment and in the perpendicular direction the dimension of the column remains unchanged and also the rebar percentage remains constant. For example a rebar percentage equal to 2.9 % in a 45x45 cm section, 12#25 (i.e. 12 number of rebar with a diameter size of 25 mm) was used, for the final section of this case, a 50x45 cm section with 12#26.36 was

obtained in which the rebar percentage remains 2.9%. The increment of column dimension is continued till the disappearance of the soft story mechanism, it means that when the first story drift reaches 1 % (half of the Life-Safety acceptance criteria) upper stories' walls fail and story drift is distributed between stories. This leads the structure to have more ductile behavior and there is no drift localization in the first story. Reaching the final state, the ratio of the strength of the final column to the strength of the initial columns is named as overstrength factor  $\alpha$ . In Figures 8 and 9 obtaining  $\alpha$  factor for model 3-O in 3 story frame is shown [6].

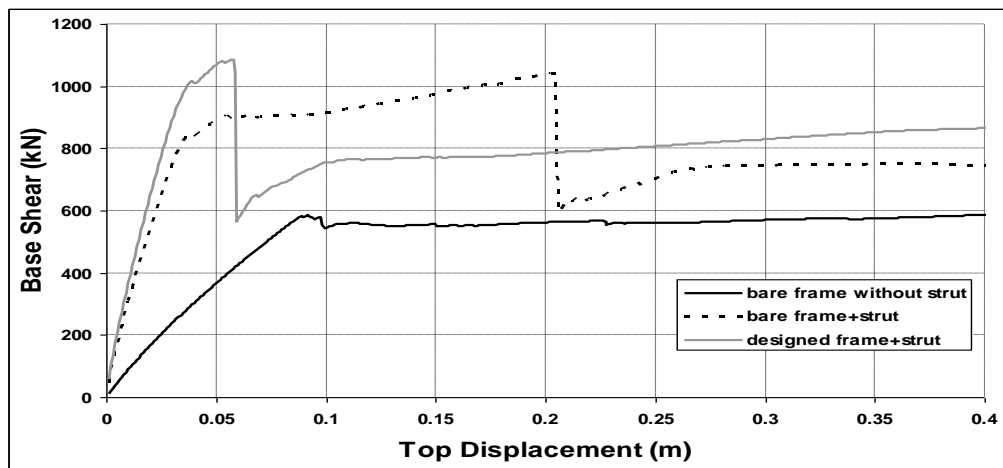

**Fig. 8.** Pushover curves for 3 story frame model 3-O with 17 cm thickness.



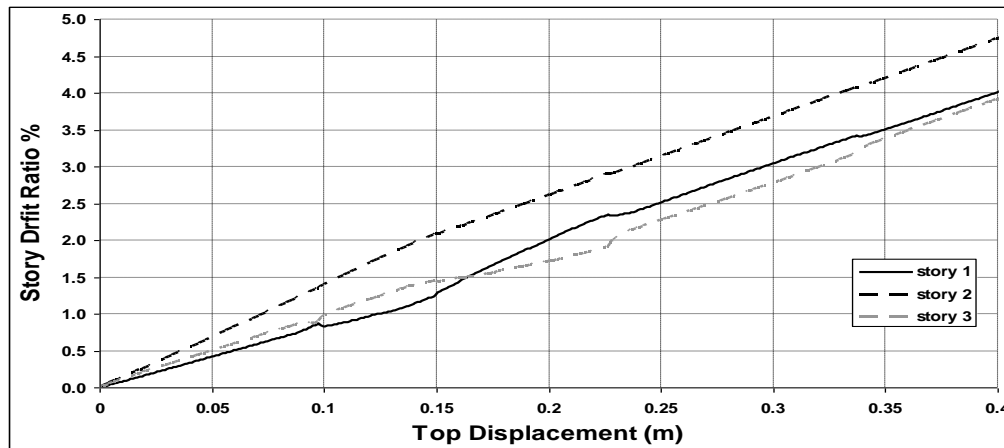

Fig. 9. Story drift for 3 story frame model 0-bare frame without strut.

As shown in Fig.8 adding masonry infill walls lead to stiffening the structure and the slope at the pushover curves will increase therefore the maximum strength will increase. Since infill walls are brittle material and have high stiffness, in the distribution of forces between elements, these walls bear a large amount of lateral load till they fail. After the failure of infill walls, a drop in stiffness (slope) and strength of pushover curves occurs [30]. As can be seen in Fig.8, after the failure of the infill walls the slope of the pushover curve will be the same as model zero 0 (bare frame) [31–35]. Now to obtain the  $\alpha$  factor the maximum strength in pushover curves for two cases should be compared. The first case is the bare frame with masonry struts in upper stories model 3-O (bare frame + strut) and the second one is the bare frame with masonry strut in upper stories with stronger first story columns (designed frame + strut) [1,2,6]:

$$\alpha = \frac{V_2}{V_1} = \frac{1109563}{884677} = 1.2542 \quad (2)$$

As shown in the pushover curves, by considering infill walls the stiffness and strength of buildings are increased compared to a building without considering infill walls. It is a valuable phenomenon and has

engineering advantages, but because of the discontinuity of infill walls in the first story, the stiffness and strength of this story are less than the upper story causing localizations of drift and deformations in this story. As shown in Fig.10, first-story drift increases rapidly and plastic hinges form in the first story's columns. Fig.9 shows story drift for 3 stories bare frame model 0 (bare frame without strut), as it was predictable, drifts of the frame are distributed along with the height of the frame. Fig.10 shows story drift for 3 story frames with infill of 17 cm thickness model 3-O (bare frame+strut) versus top displacement. Drift concentration in story 1 is seen. If the first story is designed by overstrength factor  $\alpha$  as shown in Fig.11, there will be no deformation localization in the first story and all story drifts are increasing uniformly. Fig.11 shows story drift for 3 story frame model 3-O (designed frame+strut) that has been designed for the soft story. It is seen that there is no drift concentration in stories. Fig.12 shows masonry infill shear versus top displacement for 3 story frame model 3-O (designed frame+strut) and Fig.13 shows masonry strut's shear versus each story drift for 3 story frame model 3-O (designed frame+strut) which both of them show the efficiency of the strut model.

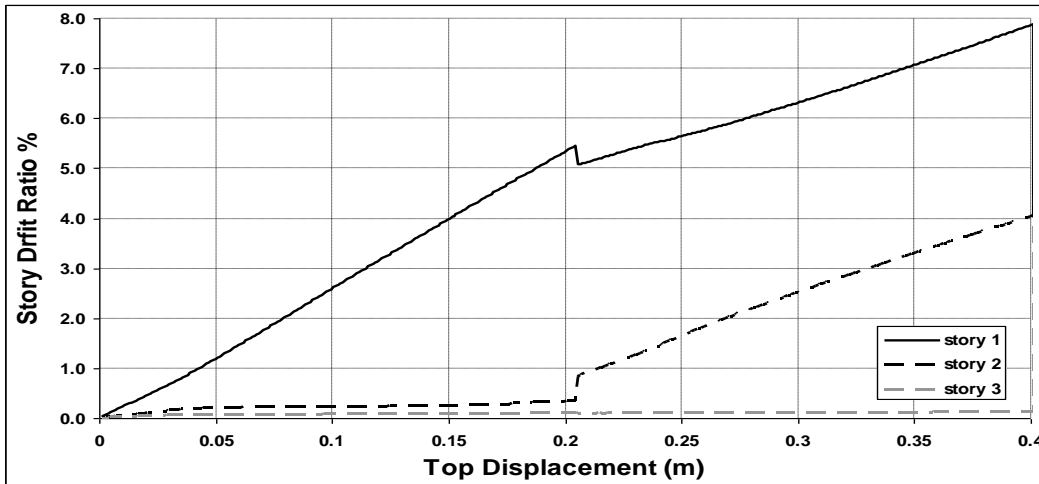

Fig. 10. Story drift for 3 story frame model 3-O with 17 cm thickness-bare frame+strut.

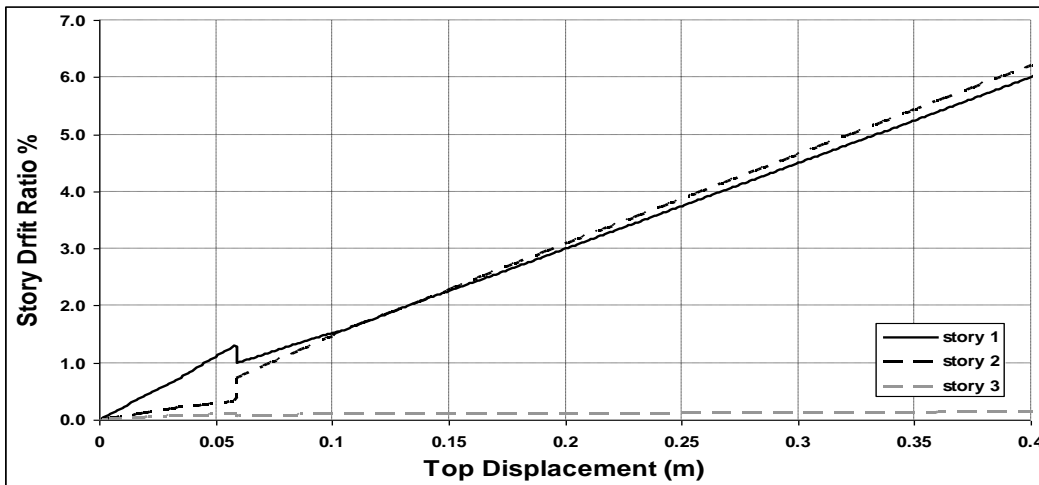

Fig. 11. Story drift for 3 story frame model 3-O with 17 cm thickness-designed frame+strut

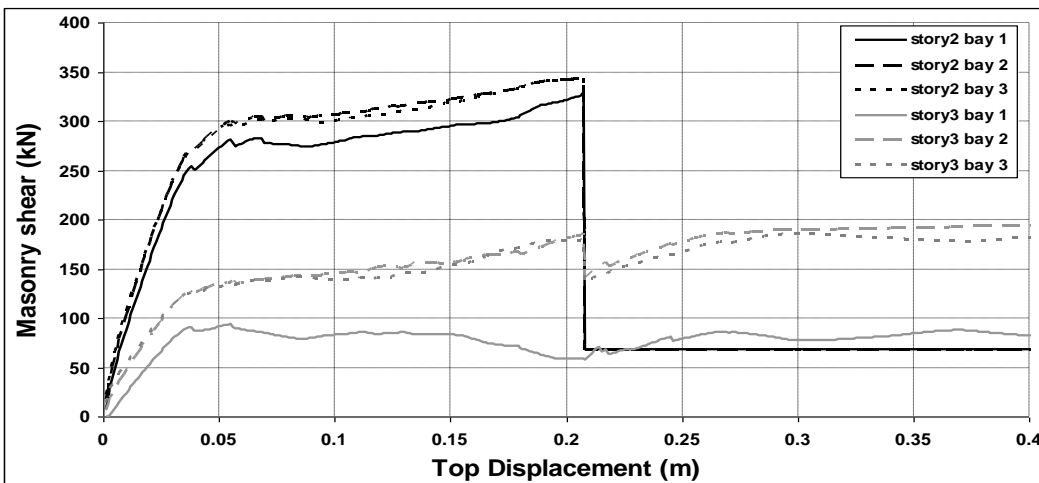

Fig. 12. Masonry infill shear versus top displacement for 3 story frame model 3-O with 17 cm -designed frame+strut.



Fig. 13. Masonry infill shear versus story drift for 3 story frame model 3-O with 17 cm thickness - designed frame+strut.

### 6. Pushover Analyses Results

For 5 story and 9 story frames, the same procedures have been done and the results show the same effect of masonry infill walls. The obtained results of analyzing the models are shown in the tables below. These results help us to find a reasonable trend in the

overstrength factor  $\alpha$  in different models. As can be seen from the tables 7 and 8, the masonry infill walls have less effect on the frames' behavior of 5 and 9 story frames since the columns of these frames are big in size and so are stronger than the masonry infill walls.

Table 6. Overstrength factor  $\alpha$  for 3 story frame.

Infill	17,(L/3)opening			17,wo opening			23,(L/3)opening			23,wo opening		
	1-O	2-O	3-O	1-W	2-W	3-W	1-O	2-O	3-O	1-W	2-W	3-W
$\alpha$	1	1	1.25	1	1.68	2.69	1	1.39	1.74	1.38	2.6	4.03

Table 7. Overstrength factor  $\alpha$  for 5 story frame.

Infill	17,(L/3)opening			17,wo opening			23,(L/3)opening			23,wo opening		
	1-O	2-O	3-O	1-W	2-W	3-W	1-O	2-O	3-O	1-W	2-W	3-W
$\alpha$	1	1	1	1	1.38	1.91	1	1	1.43	1	1.79	3.84

Table 8. Overstrength factor  $\alpha$  for 9 story frame.

Infill	17,(L/3)opening			17, wo opening			23,(L/3)opening			23, wo opening		
	1-O	2-O	3-O	1-W	2-W	3-W	1-O	2-O	3-O	1-W	2-W	3-W
$\alpha$	1	1	1	1	1	1.3	1	1	1	1	1.3	1.67

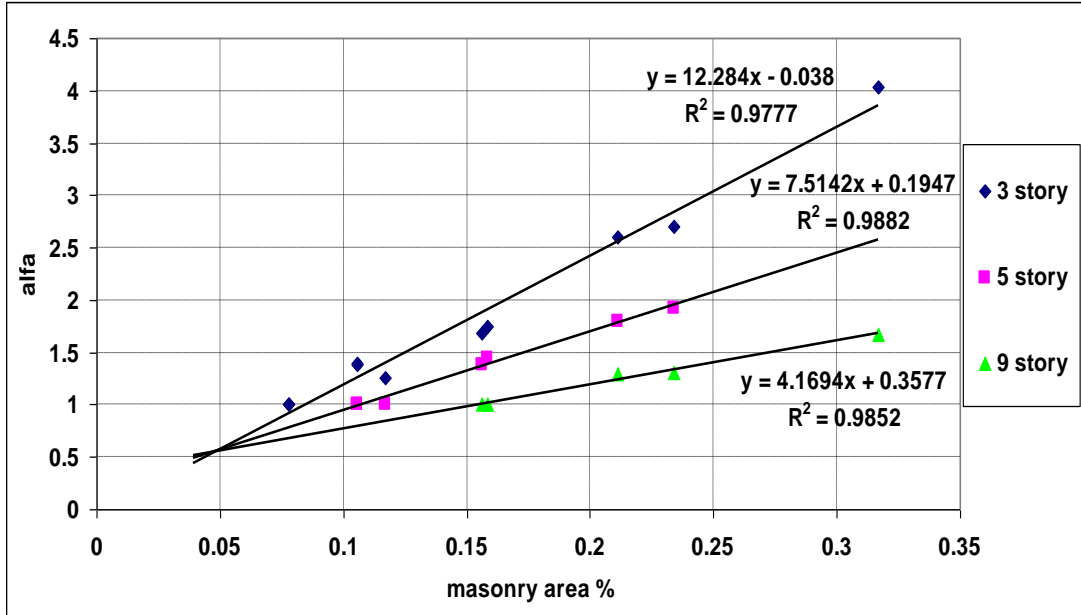

Fig. 14. Overstrength factor  $\alpha$  for 3,5,9 story frames.

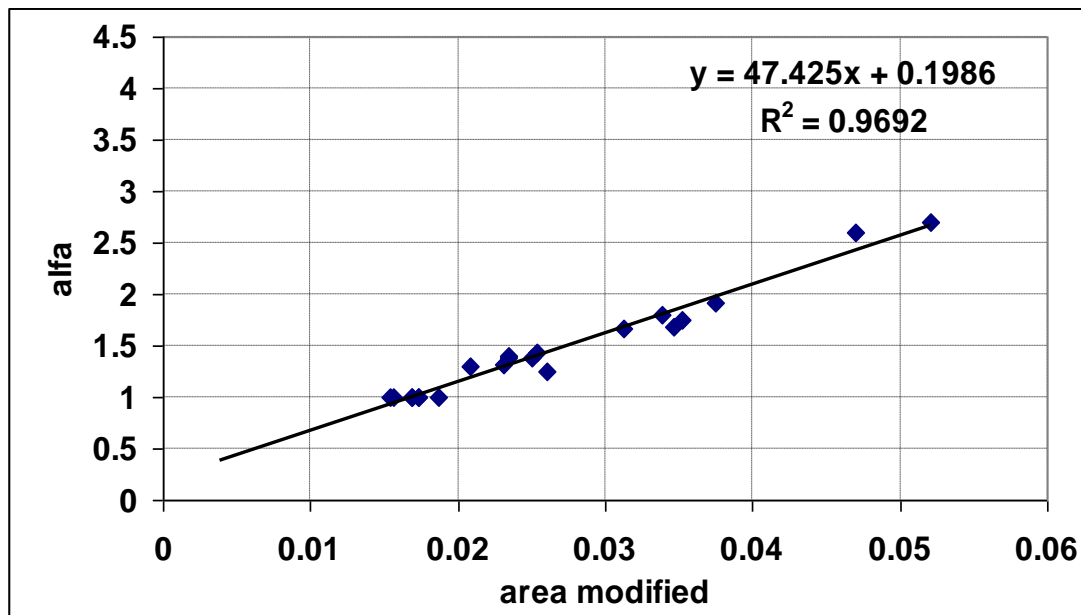

Fig. 15. Overstrength factor  $\alpha$  in general.

The results show that by increasing the ratio and thickness of infill walls, this factor ( $\alpha$ ) increases; also by increasing the number of stories (increasing column's dimension) the effects of infill wall decrease. The overstrength factor  $\alpha$  for 9 story frame is greater than one in just three cases as shown in Table 8.

Remarkably, obtained values for  $\alpha$  factor for different buildings are related to each other as shown in Fig.14. If we modify the masonry strut area ratio (masonry strut area divided by plan area multiplied by the number of stories minus one, divided by square of the number of stories) all the points in Fig.14 could be illustrated in Fig.15.

According to Figure 15, for each number of stories between 3 to 9 in the case of the probability of soft-story failure, the  $\alpha$  factor would be obtained from equation (3) based on masonry area:

$$\alpha = 50 \times \left( \frac{A_{infills}}{A_{plan}} \right) \times \frac{N-1}{N^2} + 0.2 \quad (3)$$

In this formula  $A_{infills}$  is the cross-sectional area of equivalent masonry struts,  $A_{plan}$  is the total area of the building's plan, and N is the number of stories of the building.

The design of soft-story due to the discontinuity of masonry infill walls was investigated in this paper. For this purpose, some case studies including 3-, 5- and 9-story RC frames with intermediate moment-resisting frames were carried out and all of these structures were the same in the plan. The frames were designed based on the Iranian Seismic Code of practice (Standard No. 2800) for lateral and gravity loads. It is notable that the Iranian Seismic Code of practice is very similar to UBC-97 and therefore, it covers many buildings around the world. Several arrangements of infill walls with different thicknesses and openings were considered. The main aim of this paper was to investigate the soft story failure mechanism in the first story of these buildings according to patterns of infill walls distribution and determine  $\alpha$  factor for strengthening first story columns to avoid soft-story failure, named the overstrength factor equal to 2.8 in Iranian Building Code. The Iranian Code considers shear walls and braces discontinuity only, but the obtained factor considers discontinuity of masonry infill walls. To determine this factor, nonlinear pushover analysis was applied by choosing each case and analyzing it. Finally, all data of this factor for several buildings

and patterns were illustrated in one diagram and by eliminating the effects of the numbers of stories in these data a unit curve and equation were obtained for determining this factor in structures at the design phase.

The structure with an equivalent strut is analyzed using pushover analysis, and drift localization in the first story was observed, in this state first story columns reached collapsed drift (4%) after a little displacement, but the upper story drifts were so much smaller than the first story.

In the next analysis, by increasing the dimension of columns by 2.5 (cm) steps with fixed longitudinal rebar percentage section properties of columns were obtained to avoid soft-story failure in the first story, and this led to the distribution of drift between stories. Finally, the overstrength factor  $\alpha$  was obtained by comparing the final column's strength and the initial column's strength.

## 7. Conclusions

The most important conclusions are as follows:

- The overstrength factor for several states was obtained and a good and reasonable trend was observed. Pushover curves show the importance of infill walls' effects on the structure's behavior and localization of stress and drift.
- Low strength or thin infill walls have an overstrength factor of the unit, which means that there is no need to strengthen the first-story columns.
- In the design procedure by calculating the infill walls ratio using architectural plans and the number of stories the overstrength factor  $\alpha$  could be

determined and applied in designing by formulae represented in equation (3).

- For strengthening existing buildings (rehabilitation), building masonry infill walls in the first story bays, or using friction dampers or rehabilitating the first story's columns is recommended. The first option it means adding masonry infill walls in the first story to eliminate the discontinuity of the stiffness and strength of the structure by adding these walls in the first story, but some times in the first story we have parking or stores so we cannot add these walls. The second option will increase the stiffness and strength of the first floor which may be expensive because of these new and costly devices and the third option means adding concrete jacketing to the first story to increase the stiffness and strength of the first story which this option is more comfortable and cheaper than the second one.

## References

- [1] Tabeshpour MR, Golafshani AA, Hosseini Gelekolai SM. The Overstrength Factor in Soft Story Design due to Removal of Masonry Infill Walls (in Persian). 1st Natl. Conf. Structure, Earthq. Geotech., Babolsar, Iran: 2010.
- [2] S. M. Hosseini-Gelekolai MRT. Soft Story Design in Reinforced Concrete Structure and Effect of Masonry Infill Wall. Sixth Int. Conf. Seismol. Earthq. Eng., 2011, p. 1–8.
- [3] Naderpour H, Rezazadeh Eidgahee D, Fakharian P, Rafiean AH, Kalantari SM. A new proposed approach for moment capacity estimation of ferrocement members using Group Method of Data Handling. *Eng Sci Technol an Int J* 2020;23:382–91.
- [4] Vicente RS, Rodrigues H, Varum H, Costa A, Mendes da Silva JAR. Performance of masonry enclosure walls: lessons learned from recent earthquakes. *Earthq Eng Vib* 2012;11:23–34. <https://doi.org/10.1007/s11803-012-0095-3>.
- [5] Mota Silva JC, Bastos L de S, Santos da Silva JG. Human Comfort Assessment of Buildings Considering the Effect of the Masonry Infills and the Soil-Structure Interaction. *Comput. Eng. Phys. Model.*, vol. 2, 2019, p. 38–52.
- [6] Hosseini Gelekolai SM, Golafshani AA, Tabeshpour MR. Design of Soft Story in Reinforced Concrete Structure due to Removal of Masonry Infill Wall. Sharif University of Technology, 2010.
- [7] Tabeshpour MR. Masonry infills in structural frames (Handbook, Part 18) (in Persian). Tehran, Iran: FadakIsatis Publisher; 2009.
- [8] Tabeshpour MR. Seismic retrofit of infilled frames (Handbook, Part 19) (in Persian). Tehran, Iran: FadakIsatis Publisher; 2009.
- [9] Tabeshpour MR, Azad A, Golafshani AA. Seismic Behavior and Retrofit of Infilled Frame. *Earthquake-Resistant Struct. - Des. Assessment, Rehabil.*, InTech, Croatia; 2012.
- [10] Shahahebi A, Waezi Z, Hashemi MJ. Seismic performance assessment of multi-story RC buildings with soft-story collapse mechanism equipped with gapped inclined bracing (GIB). *Structures* 2020;28:2448–66. <https://doi.org/10.1016/j.istruc.2020.10.068>.
- [11] Moghaddam H, Hosseini Gelekolai SM. Optimum Seismic Design of Short to Mid-Rise Steel Moment Resisting Frames Based on Uniform Deformation Theory. *J Seismol Earthq ...* 2017;19:13–24. <https://doi.org/10.1016/j.jestch.2019.05.013>.

- [12] Harati M, Mashayekhi M, Khansefid A, Pourzeynali S, Bahar A. Nonlinear behavior of RC shear walls: From experiments to the field reports 2020. <https://doi.org/10.13140/RG.2.2.31639.52647>.
- [13] Building and Housing Research Center. Iranian Seismic Code of Practice (Standard No. 2800), 3rd edition. Tehran, Iran: 2005.
- [14] Building and Housing Research Center. Iranian Seismic Code of Practice (Standard No. 2800), 4rd edition. Tehran, Iran: 2014.
- [15] Armağan KORKMAZ K, Demr F, Svr M. Earthquake Assessment of R/C Structures with Masonry Infill Walls. *Int J Sci Technol* 2017;2:155–64.
- [16] Mostafaei H, Toshimi K. Effect of infill masonry walls on the seismic response of reinforced concrete buildings subjected to the 2003 Bam earthquake strong motion: a case study of Bam telephone center. *Bull Earthq Res Institute, Univ Tokyo* 2004;79:133–56.
- [17] Committee BD-004. Australian Standard AS 3700 Masonry Structures. 2018.
- [18] Kanchidurai S, Krishnan PA, Baskar K. Compressive strength estimation of mesh embedded masonry prism using empirical and neural network models. *J Soft Comput Civ Eng* 2020;4:24–35. <https://doi.org/10.22115/SCCE.2020.228611.1213>.
- [19] Fakharian P, Rezazadeh Eidgahee D, Akbari M, Jahangir H, Ali Taeb A. Compressive strength prediction of hollow concrete masonry blocks using artificial intelligence algorithms. *Structures* 2023;47:1790–802. <https://doi.org/10.1016/j.istruc.2022.12.007>.
- [20] Hashemi A, Mosalam KM. Shake-table experiment on reinforced concrete structure containing masonry infill wall. *Earthq Eng Struct Dyn* 2006;35:1827–52. <https://doi.org/10.1002/eqe.612>.
- [21] the Building Industry Authority. Assessment and Improvement of the Structural Performance of Buildings in Earthquake. 2002.
- [22] McKenna F, Fenves GL, Scott MH. Open system for earthquake engineering simulation (OpenSees). Univ California, Berkeley, CA 2000.
- [23] Mazzoni S, McKenna F, Scott MH, Fenves GL. OpenSees command language manual. *Pacific Earthq Eng Res Cent* 2006;264:137–58.
- [24] Hosseini Gelekolai SM, Kenarangi H. Application of Openses Software in Structural Modeling and Analysis. Tehran, Iran: Azadeh Publications.(In Persian); 2013.
- [25] Hashemi A, Mosalam KM. Seismic Evaluation of Reinforced Concrete Buildings Including Effects of Masonry Infill Walls. *Pacific Earthq Engineering Cent* 2007:1–250.
- [26] Taucer F, Spacone E, Filippou FC. A fiber beam-column element for seismic response analysis of reinforced concrete structures. vol. 91. *Earthquake Engineering Research Center, College of Engineering, University ...*; 1991.
- [27] Moghaddam H, Hajirasouliha I, Hosseini Gelekolai SM. Performance-based seismic design of moment resisting steel frames: Adaptive optimisation framework and optimum design load pattern. *Structures* 2021;33:1690–704. <https://doi.org/10.1016/j.istruc.2021.05.014>.
- [28] Moghaddam H, Hosseini Gelekolai SM, Hajirasouliha I, Tajalli F. Evaluation of Various Proposed Lateral Load Patterns for Seismic Design of Steel Moment Resisting Frames. *15th World Conf Earthq Eng* 2012.
- [29] Moghaddam H, Hosseini Gelekolai SM, Hajirasouliha I. More efficient lateral load patterns for seismic design of steel moment-resisting frames. *Proc Inst Civ Eng - Struct Build* 2018;171:487–502. <https://doi.org/10.1680/jstbu.17.00064>.

- [30] Hashmi AK, Madan A. Damage forecast for masonry infilled reinforced concrete framed buildings subjected to earthquakes in India. *Curr Sci* 2008;94:61–73.
- [31] Sattar S, Liel AB. Seismic performance of reinforced concrete frame structures with and without masonry infill walls. 9th US Natl. 10th Can. Conf. Earthq. Eng. 2010, Incl. Pap. from 4th Int. Tsunami Symp., vol. 3, 2010, p. 1864–73.
- [32] Moghaddam H, Hosseini Gelekolai SM. OPTIMAL SEISMIC DESIGN OF STEEL MOMENT RESISTING FRAMES. 7th Int. Conf. Seismol. Earthq. Eng., Tehran, Iran: 2015.
- [33] Moghaddam H, Hosseini Gelekolai SM, Hajirasouliha I. OPTIMUM SEISMIC DESIGN OF STEEL MOMENT RESISTING FRAMES USING TIME HISTORY ANALYSIS. 16th World Conf. Earthq. Eng. 16WCEE, Santiago Chile: 2017.
- [34] Moghaddam H, Moini B, Hosseini Gelekolai SM. Rehabilitation of Steel Moment Resisting Frames using Friction Dampers. 9th Natl. Congr. Civ. Eng., Mashhad, Iran: 2016.
- [35] Hosseini Gelekolai SM. Application of Adaptive Method in Optimum Seismic Design of Steel Moment Resisting Frames and Dampers. Sharif University of Technology, 2018.